



**INSTRUCTIONS D'ASSEMBLAGE**  
**ASSEMBLY INSTRUCTIONS**

---

**M**ONARCH  
SPECIALTIES INC.

# 8P32061

---

**CAUSEUSE INCLINABLE -  
MOTORISER / USB PU BRUN # TJB-061**

**RECLINING LOVE SEAT -  
POWER / USB BROWN PU # TJB-061**





**POUR DE L'ASSISTANCE OU POUR COMMANDER  
DES PIÈCES CONTACTEZ NOTRE DÉPARTEMENT  
DE SERVICE À LA CLIENTÈLE.**

**FOR ASSISTANCE OR TO ORDER PARTS  
CONTACT OUR CUSTOMER SERVICE DEPARTMENT**

**WWW.MONARCHSERVICE.COM**

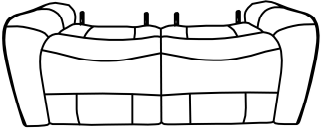
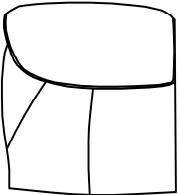
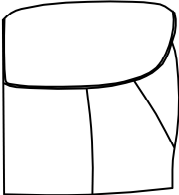
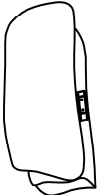

**LISTE DES PIÈCES**  
**PARTS LIST**

PIÈCE / PART #	IMAGE	DESCRIPTION	QTY / QTÉ
1		<p>RECLINER SEAT ASSISE DE FAUTEUIL INCLINABLE</p>	1
2		<p>RECLINER FRONT FACING LEFT BACK REST DOSSIER INCL. AVANT GAUCHE</p>	1
3		<p>RECLINER FRONT FACING RIGHT BACK REST DOSSIER INCL. AVANT DROIT</p>	1
4		<p>FRONT FACING LEFT SIDE WING AILETTE AVANT GAUCHE</p>	1
5		<p>FRONT FACING RIGHT SIDE WING AILETTE AVANT DROITE</p>	1

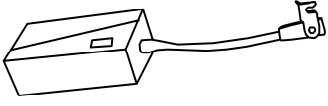
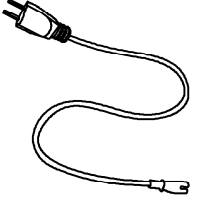
**LISTE DES PIÈCES**  
**PARTS LIST**

PIÈCE / PART #	IMAGE	DESCRIPTION	QTY / QTÉ
6		<p align="center">AC/DC ADAPTOR ADAPTEUR AC/DC</p>	1
7		<p align="center">PLUG FICHE ÉLECTRIQUE</p>	1
<p align="center"><b>LISTE DES PIÈCES (DÉJÀ INSTALLÉES)</b> <b>PARTS LIST (ALREADY INSTALLED)</b></p>			
8		<p align="center">SUPPORT LEG PATTE DE SUPPORT</p>	8

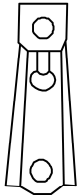
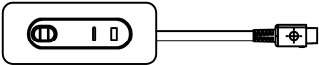
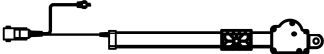
**LISTE DES PIÈCES DE MONTAGE**  
**HARDWARE LIST**

PIÈCE / PART #	IMAGE	DESCRIPTION	QTY / QTÉ
<b>LISTE DES PIÈCES DE MONTAGE (DÉJÀ INSTALLÉES)</b> <b>HARDWARE LIST (ALREADY INSTALLED)</b>			
<b>A</b>		<b>METAL BRACKET</b> <b>SUPPORT EN MÉTAL</b>	<b>4</b>
<b>B</b>		<b>POWER SWITCH</b> <b>INTERRUPTEUR</b>	<b>2</b>
<b>C</b>		<b>MOTOR</b> <b>MOTEUR</b>	<b>2</b>
<b>D</b>		<b>METAL BRACKET SET</b> <b>ENSEMBLE DE SUPPORT EN MÉTAL</b>	<b>2</b>

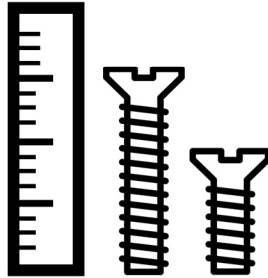

OUTIL DE VÉRIFICATION DE DIMENSIONS DES PIÈCES  
HARDWARE DIMENSIONS VERIFICATION TOOL



**ÉTAPE / STEP 1**

VOUS DEVEZ ENLIGNER LES DEUX GLISSOIRS DU DOSSIER AVEC LES DEUX TIGES DU SIÈGE EN MÊME TEMPS ET POUSSER VERS LE BAS POUR LES ENCLANCHER.

ALIGN THE TWO BACKREST BRACKETS WITH THE TWO SEAT HOOKS AND PUSH DOWN TO HOOK TOGETHER.

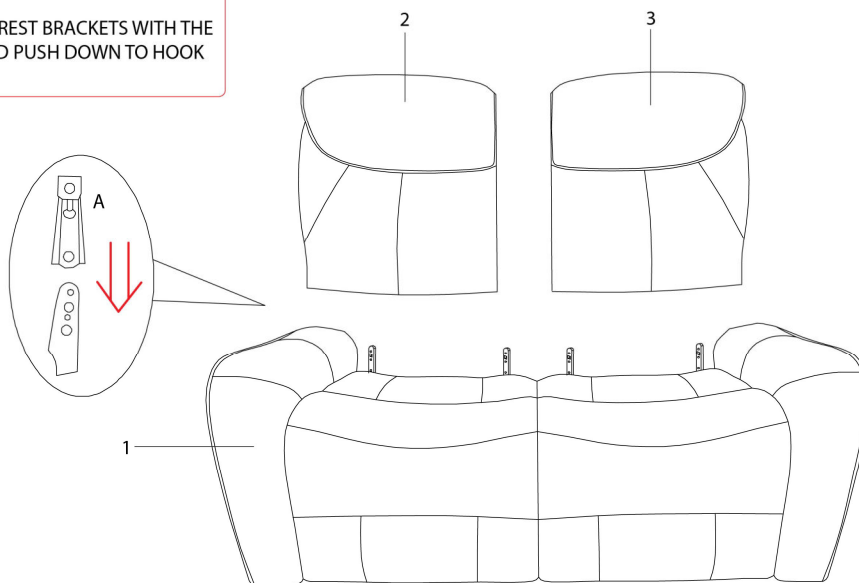

**ÉTAPE / STEP 2**

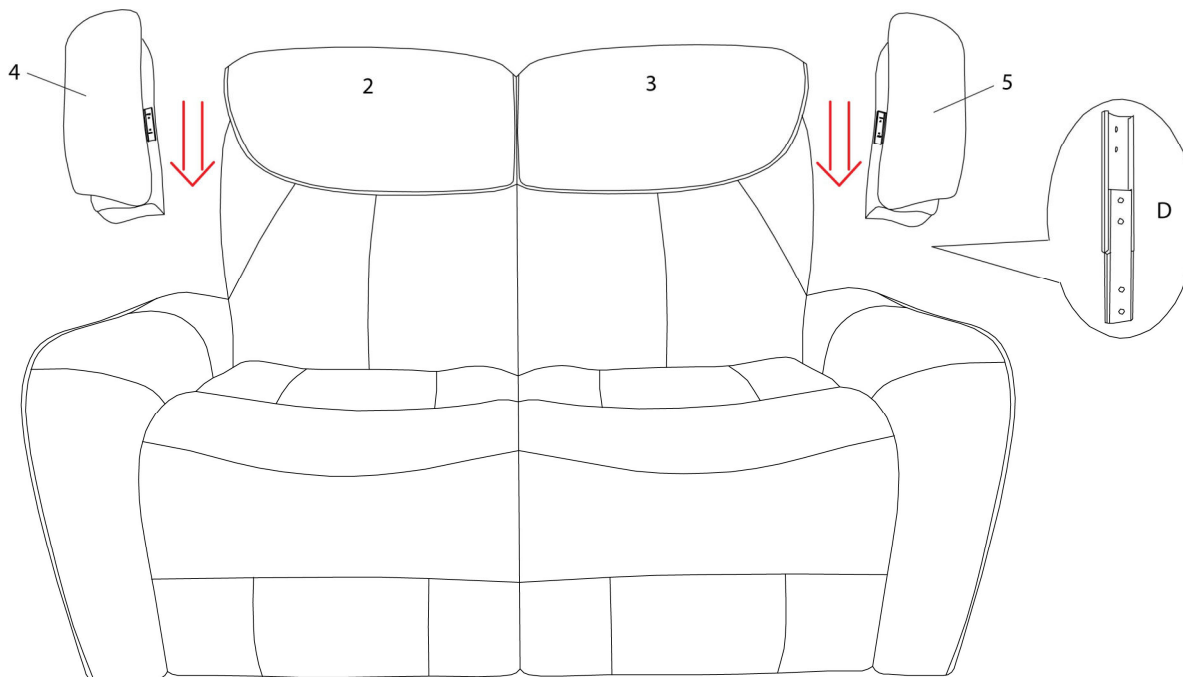

**ÉTAPE / STEP 3**

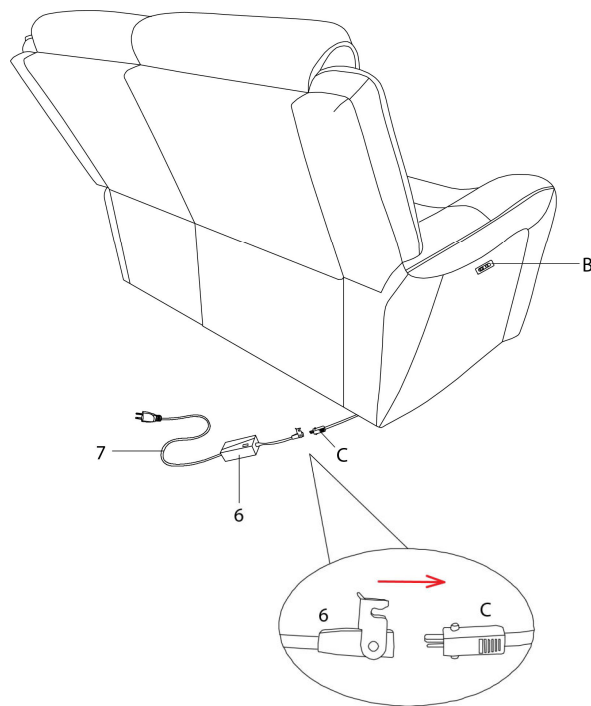

**ÉTAPE / STEP 4**

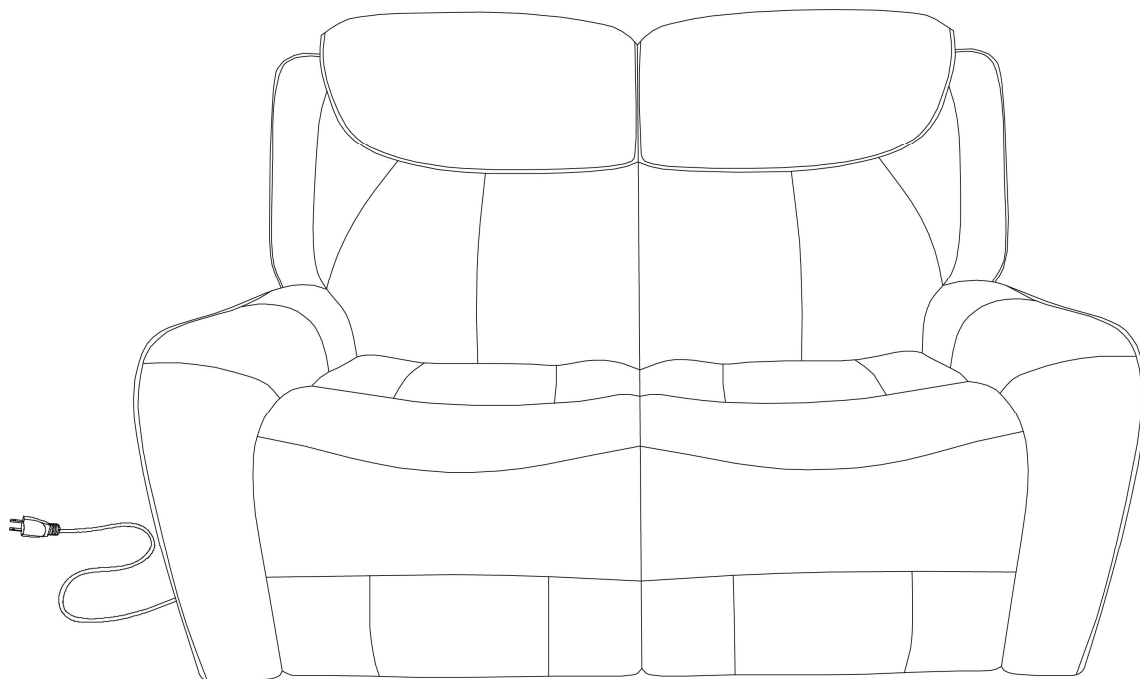

ÉTAPE / STEP 5

