



**INSTRUCTIONS D'ASSEMBLAGE  
ASSEMBLY INSTRUCTIONS**

---

**M**ONARCH  
SPECIALTIES INC.

# 8P31061

---

**FAUTEUIL INCLINABLE -  
PIVOTANT MOTO. / USB PU BRUN TJB-061**

**RECLINING CHAIR -  
POWER SWIVEL GLIDER / USB BROWN PU TJB-061**



**POUR DE L'ASSISTANCE OU POUR COMMANDER  
DES PIÈCES CONTACTEZ NOTRE DÉPARTEMENT  
DE SERVICE À LA CLIENTÈLE.**

**FOR ASSISTANCE OR TO ORDER PARTS  
CONTACT OUR CUSTOMER SERVICE DEPARTMENT**

**WWW.MONARCHSERVICE.COM**

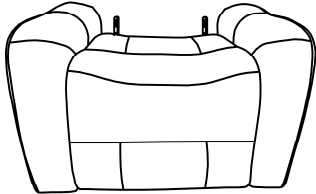
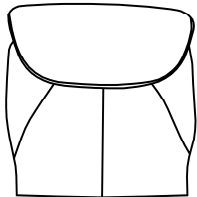
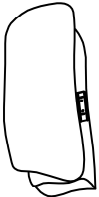
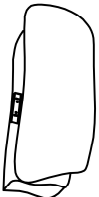
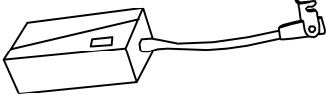

**LISTE DES PIÈCES**  
**PARTS LIST**

| PIÈCE / PART # | IMAGE                                                                               | DESCRIPTION                                                  | QTY / QTÉ |
|----------------|-------------------------------------------------------------------------------------|--------------------------------------------------------------|-----------|
| 1              |    | <p>RECLINER SEAT<br/>ASSISE DU FAUTEUIL INCLINABLE</p>       | 1         |
| 2              |    | <p>RECLINER BACK REST<br/>DOSSIER DE FAUTEUIL INCLINABLE</p> | 1         |
| 3              |  | <p>FRONT FACING LEFT SIDE WING<br/>AILETTE AVANT GAUCHE</p>  | 1         |
| 4              |  | <p>FRONT FACING RIGHT SIDE WING<br/>AILETTE AVANT DROITE</p> | 1         |
| 5              |  | <p>AC/DC ADAPTOR<br/>ADAPTEUR AC/DC</p>                      | 1         |

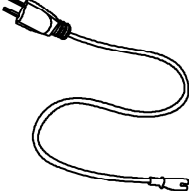
**LISTE DES PIÈCES**  
**PARTS LIST**

| PIÈCE / PART # | IMAGE                                                                             | DESCRIPTION              | QTY / QTÉ |
|----------------|-----------------------------------------------------------------------------------|--------------------------|-----------|
| 6              |  | PLUG<br>FICHE ÉLECTRIQUE | 1         |

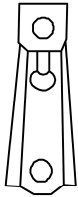
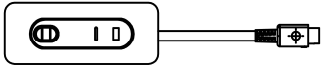
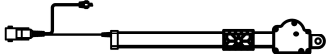
**LISTE DES PIÈCES DE MONTAGE**  
**HARDWARE LIST**

| PIÈCE / PART #                                                                                   | IMAGE                                                                               | DESCRIPTION                                                     | QTY / QTÉ |
|--------------------------------------------------------------------------------------------------|-------------------------------------------------------------------------------------|-----------------------------------------------------------------|-----------|
| <b>LISTE DES PIÈCES DE MONTAGE (DÉJÀ INSTALLÉES)</b><br><b>HARDWARE LIST (ALREADY INSTALLED)</b> |                                                                                     |                                                                 |           |
| <b>A</b>                                                                                         |    | <b>METAL BRACKET</b><br><b>SUPPORT EN MÉTAL</b>                 | <b>2</b>  |
| <b>B</b>                                                                                         |  | <b>POWER SWITCH</b><br><b>INTERRUPTEUR</b>                      | <b>1</b>  |
| <b>C</b>                                                                                         |  | <b>MOTOR</b><br><b>MOTEUR</b>                                   | <b>1</b>  |
| <b>D</b>                                                                                         |  | <b>METAL BRACKET SET</b><br><b>ENSEMBLE DE SUPPORT EN MÉTAL</b> | <b>2</b>  |

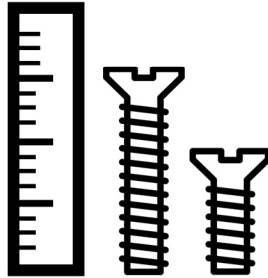

OUTIL DE VÉRIFICATION DE DIMENSIONS DES PIÈCES  
HARDWARE DIMENSIONS VERIFICATION TOOL



ÉTAPE / STEP 1

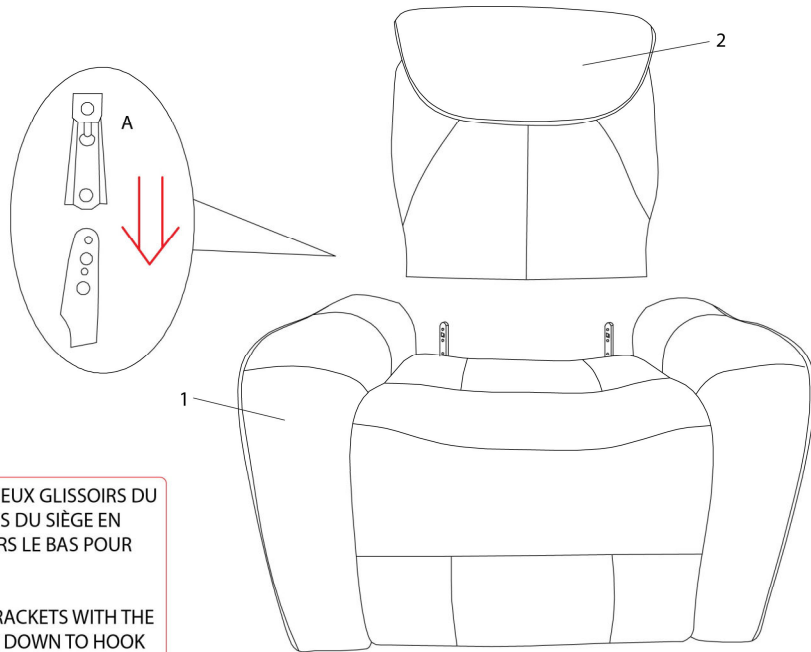

VOUS DEVEZ ENLIGNER LES DEUX GLISSOIRS DU DOSSIER AVEC LES DEUX TIGES DU SIÈGE EN MÊME TEMPS ET POUSSER VERS LE BAS POUR LES ENCLANCHER.

ALIGN THE TWO BACKREST BRACKETS WITH THE TWO SEAT HOOKS AND PUSH DOWN TO HOOK TOGETHER.

ÉTAPE / STEP 2

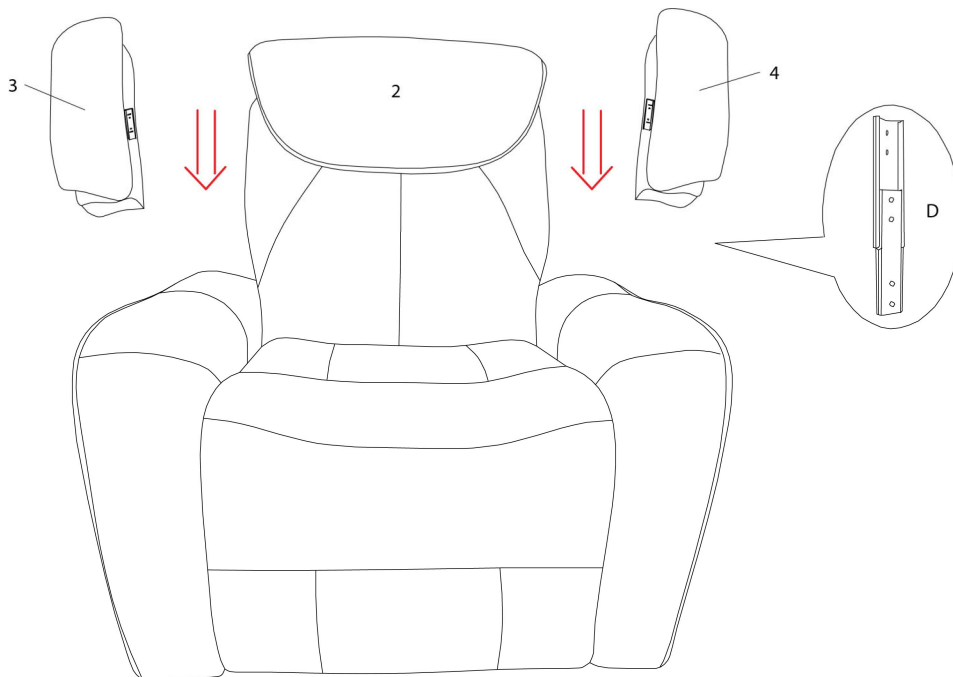



ÉTAPE / STEP 3

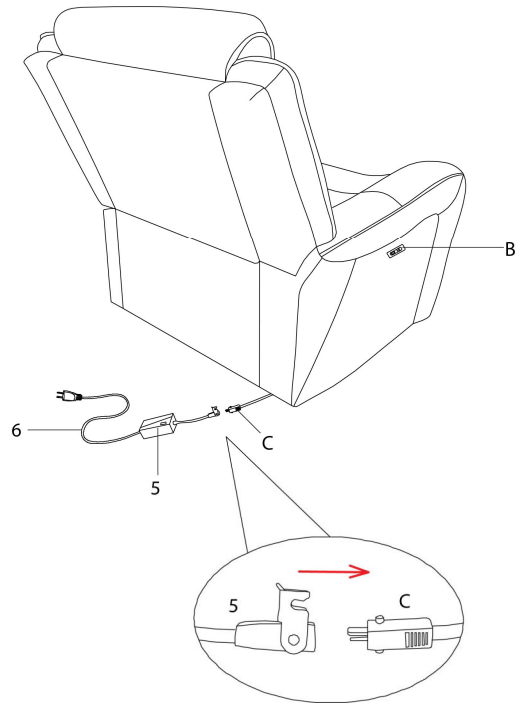

ÉTAPE / STEP 4

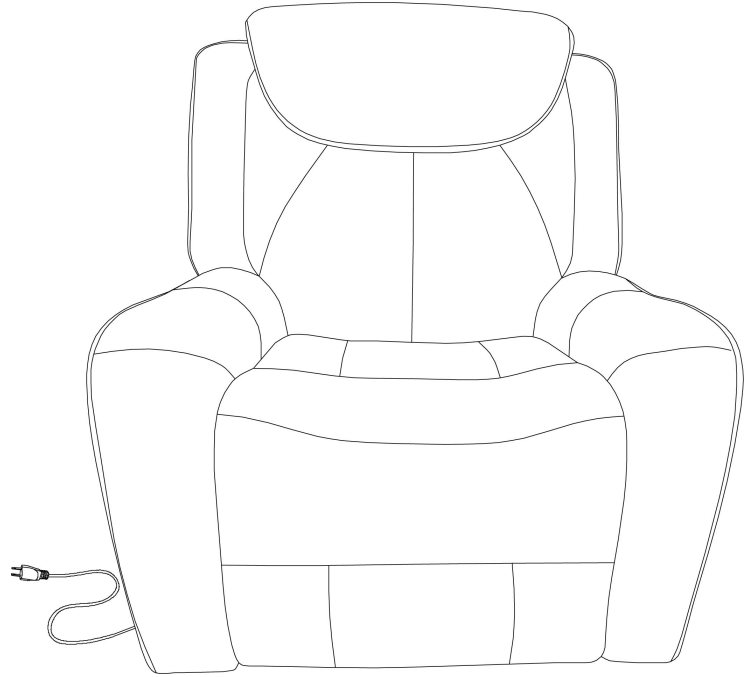

ÉTAPE / STEP 5

