



INSTRUCTIONS D'ASSEMBLAGE
ASSEMBLY INSTRUCTIONS

MONARCH
SPECIALTIES INC.

8P22406

**CAUSEUSE INCLINABLE -
MOTORISER / USB BEIGE SKY # 2514-06**

**RECLINING LOVE SEAT -
POWER / USB BEIGE FABRIC SKY # 2514-06**





**POUR DE L'ASSISTANCE OU POUR COMMANDER
DES PIÈCES CONTACTEZ NOTRE DÉPARTEMENT
DE SERVICE À LA CLIENTÈLE.**

**FOR ASSISTANCE OR TO ORDER PARTS
CONTACT OUR CUSTOMER SERVICE DEPARTMENT**

WWW.MONARCHSERVICE.COM

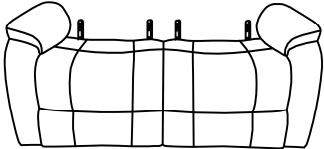
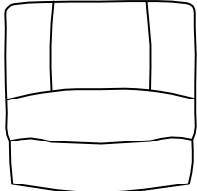
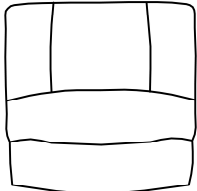

LISTE DES PIÈCES
PARTS LIST

PIÈCE / PART #	IMAGE	DESCRIPTION	QTY / QTÉ
1		<p>RECLINER SEAT ASSISE DE FAUTEUIL INCLINABLE</p>	1
2		<p>RECLINER FRONT FACING LEFT BACK REST DOSSIER INCL. AVANT GAUCHE</p>	1
3		<p>RECLINER FRONT FACING RIGHT BACK REST DOSSIER INCL. AVANT DROIT</p>	1
4		<p>FRONT FACING LEFT SIDE WING AILETTE AVANT GAUCHE</p>	1
5		<p>FRONT FACING RIGHT SIDE WING AILETTE AVANT DROITE</p>	1

LISTE DES PIÈCES
PARTS LIST

PIÈCE / PART #	IMAGE	DESCRIPTION	QTY / QTÉ
6		<p align="center">AC/DC ADAPTOR ADAPTEUR AC/DC</p>	1
7		<p align="center">PLUG FICHE ÉLECTRIQUE</p>	1
<p align="center">LISTE DES PIÈCES (DÉJÀ INSTALLÉES) PARTS LIST (ALREADY INSTALLED)</p>			
8		<p align="center">SUPPORT LEG PATTE DE SUPPORT</p>	8

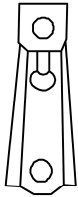
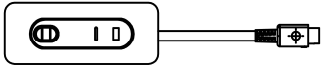
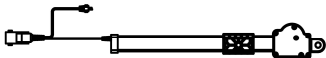
LISTE DES PIÈCES DE MONTAGE
HARDWARE LIST

PIÈCE / PART #	IMAGE	DESCRIPTION	QTY / QTÉ
<p>LISTE DES PIÈCES DE MONTAGE (DÉJÀ INSTALLÉES) HARDWARE LIST (ALREADY INSTALLED)</p>			
A		<p>METAL BRACKET SUPPORT EN MÉTAL</p>	4
B		<p>POWER SWITCH INTERRUPTEUR</p>	2
C		<p>MOTOR MOTEUR</p>	2
D		<p>METAL BRACKET SET ENSEMBLE DE SUPPORT EN MÉTAL</p>	2

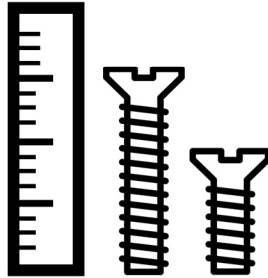

OUTIL DE VÉRIFICATION DE DIMENSIONS DES PIÈCES
HARDWARE DIMENSIONS VERIFICATION TOOL



ÉTAPE / STEP 1

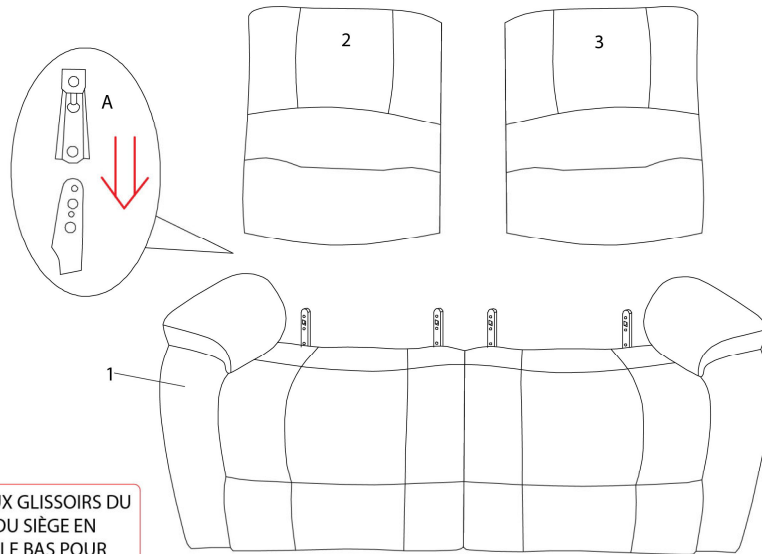

VOUS DEVEZ ENLIGNER LES DEUX GLISSOIRS DU DOSSIER AVEC LES DEUX TIGES DU SIÈGE EN MÊME TEMPS ET POUSSER VERS LE BAS POUR LES ENCLENCHER.

ALIGN THE TWO BACKREST BRACKETS WITH THE TWO SEAT HOOKS AND PUSH DOWN TO HOOK TOGETHER.

ÉTAPE / STEP 2

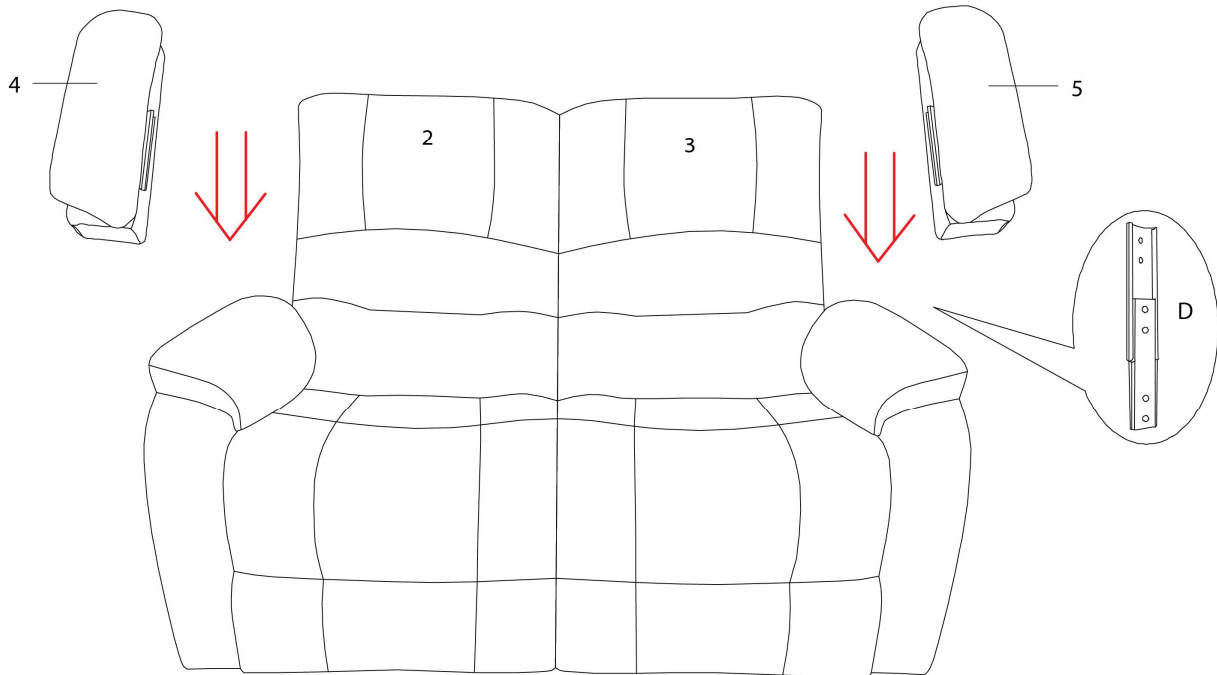

ÉTAPE / STEP 3

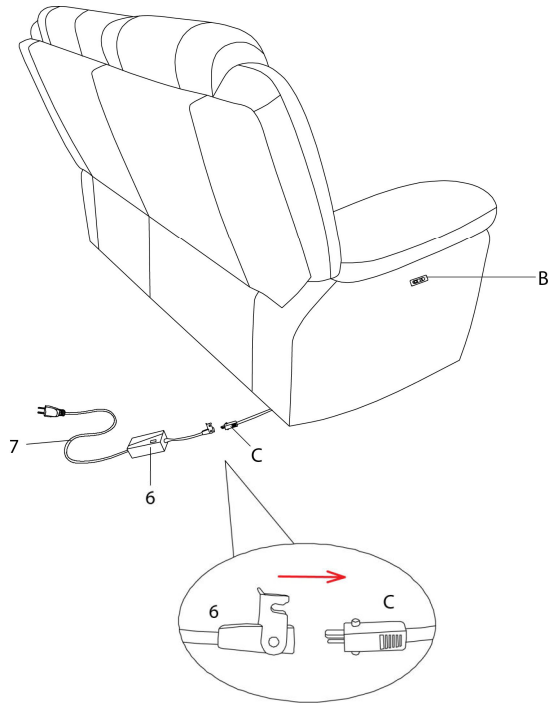

ÉTAPE / STEP 4

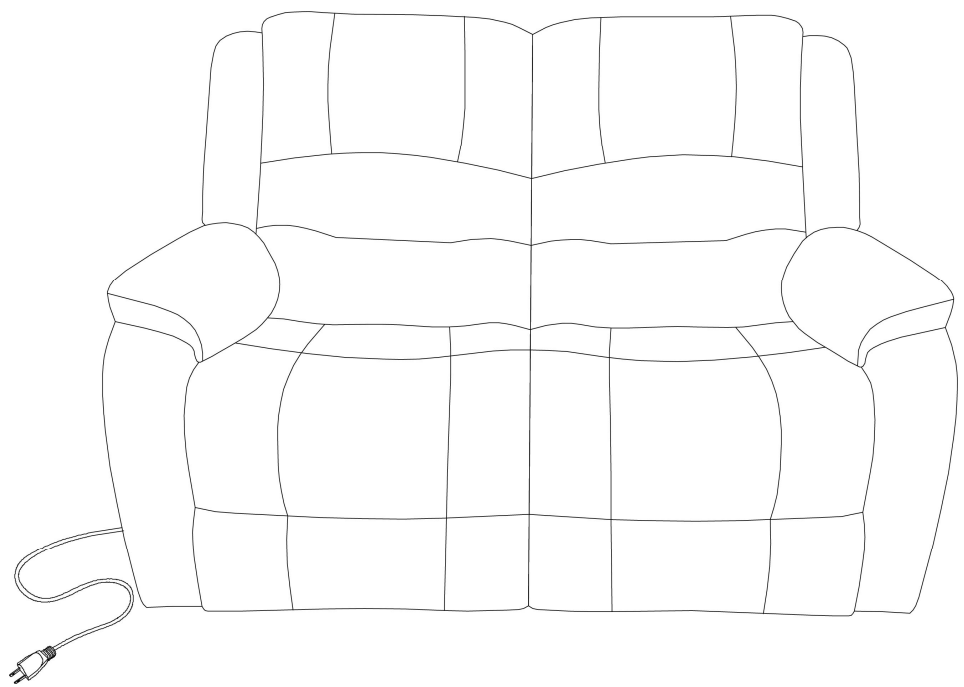

ÉTAPE / STEP 5

