



INSTRUCTIONS D'ASSEMBLAGE
ASSEMBLY INSTRUCTIONS

MONARCH
SPECIALTIES INC.

8P12106

**CAUSEUSE INCLINABLE -
MOTORISER / USB BEIGE BREEZE # 106**

**RECLINING LOVE SEAT -
POWER / USB BEIGE FABRIC BREEZE # 106**



**POUR DE L'ASSISTANCE OU POUR COMMANDER
DES PIÈCES CONTACTEZ NOTRE DÉPARTEMENT
DE SERVICE À LA CLIENTÈLE.**

**FOR ASSISTANCE OR TO ORDER PARTS
CONTACT OUR CUSTOMER SERVICE DEPARTMENT**

WWW.MONARCHSERVICE.COM

LISTE DES PIÈCES
PARTS LIST

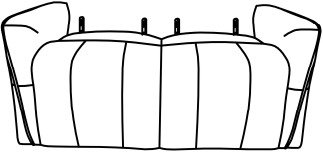
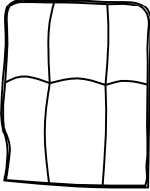
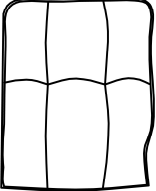
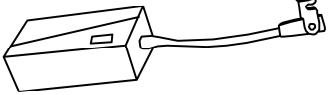
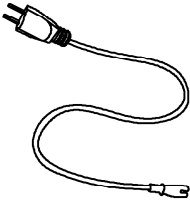
PIÈCE / PART #	IMAGE	DESCRIPTION	QTY / QTÉ
1		RECLINER SEAT ASSISE DE FAUTEUIL INCLINABLE	1
2		RECLINER FRONT FACING LEFT BACK REST DOSSIER INCL. AVANT GAUCHE	1
3		RECLINER FRONT FACING RIGHT BACK REST DOSSIER INCL. AVANT DROIT	1
4		AC/DC ADAPTOR ADAPTEUR AC/DC	1
5		PLUG FICHE ÉLECTRIQUE	1

LISTE DES PIÈCES
PARTS LIST

PIÈCE / PART #	IMAGE	DESCRIPTION	QTY / QTÉ
LISTE DES PIÈCES (DÉJÀ INSTALLÉES) PARTS LIST (ALREADY INSTALLED)			
6		SUPPORT LEG PATTE DE SUPPORT	8

LISTE DES PIÈCES DE MONTAGE
HARDWARE LIST

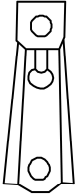
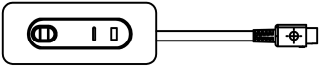
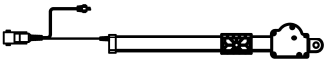
PIÈCE / PART #	IMAGE	DESCRIPTION	QTY / QTÉ
<p>LISTE DES PIÈCES DE MONTAGE (DÉJÀ INSTALLÉES) HARDWARE LIST (ALREADY INSTALLED)</p>			
A		<p>METAL BRACKET SUPPORT EN MÉTAL</p>	4
B		<p>POWER SWITCH INTERRUPTEUR</p>	2
C		<p>MOTOR MOTEUR</p>	2

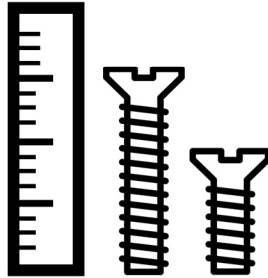

OUTIL DE VÉRIFICATION DE DIMENSIONS DES PIÈCES
HARDWARE DIMENSIONS VERIFICATION TOOL



ÉTAPE / STEP 1

VOUS DEVEZ ENLIGNER LES DEUX GLISSOIRS DU DOSSIER AVEC LES DEUX TIGES DU SIÈGE EN MÊME TEMPS ET POUSSER VERS LE BAS POUR LES ENCLANCHER.

ALIGN THE TWO BACKREST BRACKETS WITH THE TWO SEAT HOOKS AND PUSH DOWN TO HOOK TOGETHER.

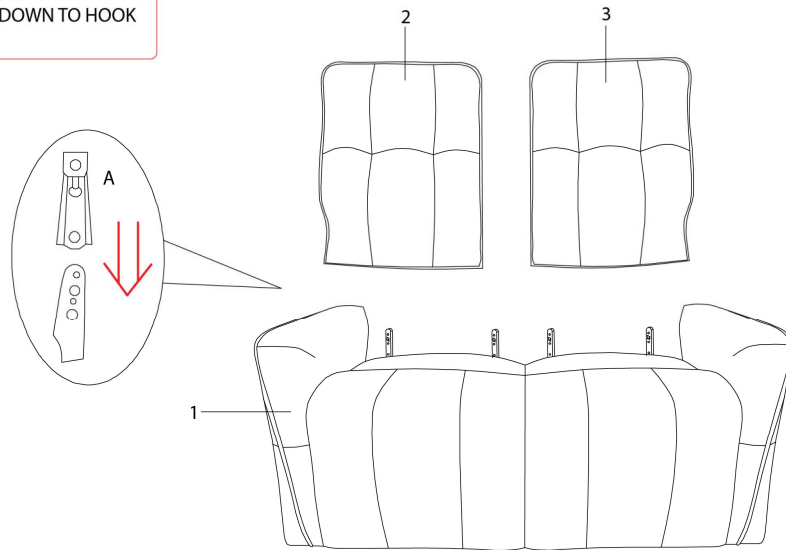

ÉTAPE / STEP 2

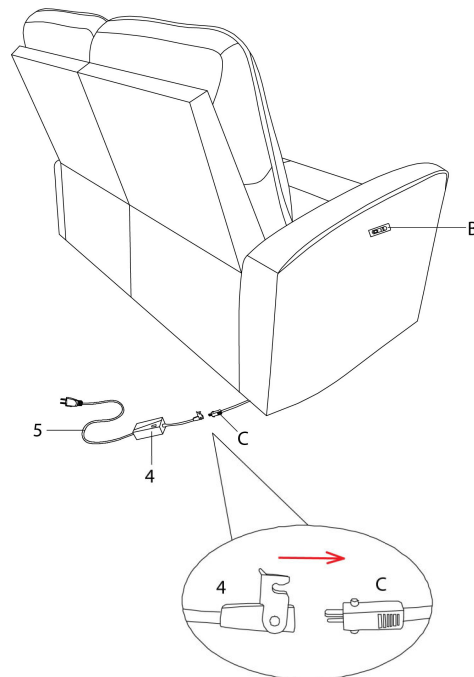

ÉTAPE / STEP 3

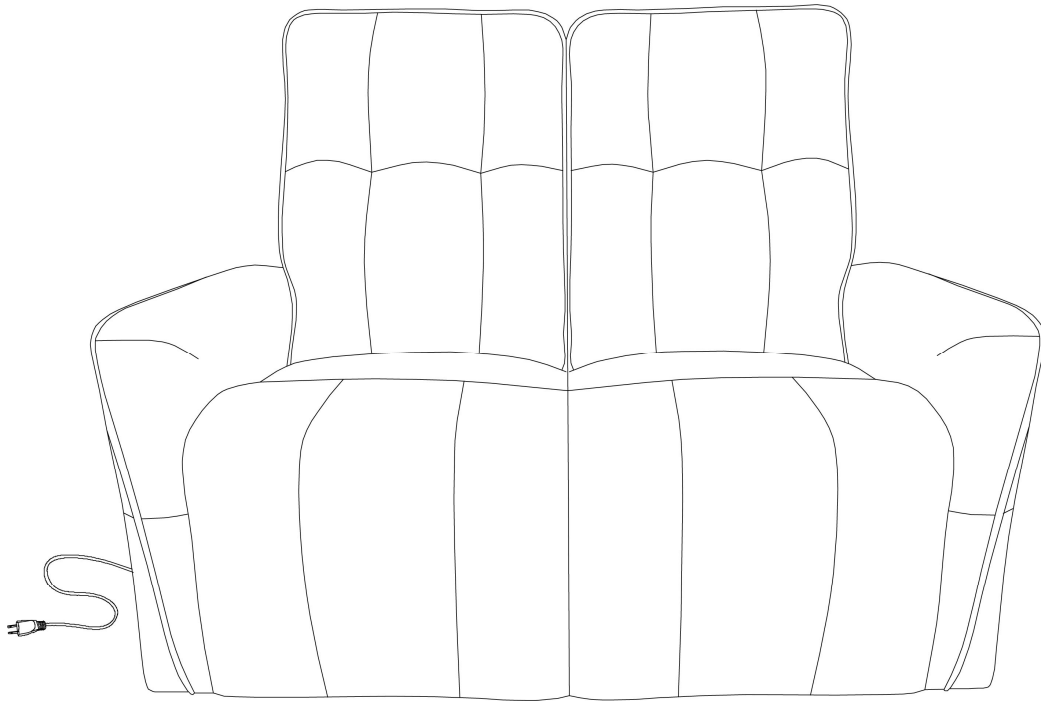

ÉTAPE / STEP 4

