



INSTRUCTIONS D'ASSEMBLAGE
ASSEMBLY INSTRUCTIONS

8J24L31

SOFA CHAISE LONGUE -
G/D / TISSU BRUN PALE #LUMOS-31

SOFA LOUNGER -
L/R FACING / LIGHT BROWN FABRIC #LUMOS-31



**POUR DE L'ASSISTANCE OU POUR COMMANDER
DES PIÈCES CONTACTEZ NOTRE DÉPARTEMENT
DE SERVICE À LA CLIENTÈLE.**

**FOR ASSISTANCE OR TO ORDER PARTS
CONTACT OUR CUSTOMER SERVICE DEPARTMENT**



WWW.MONARCHSERVICE.COM

MONARCH[®]
SPECIALTIES INC.

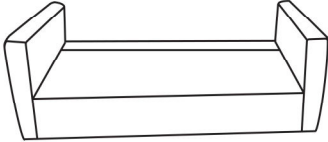
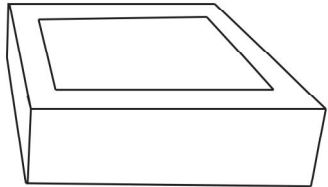
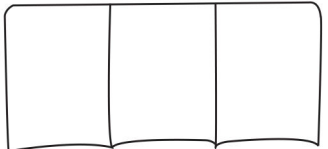
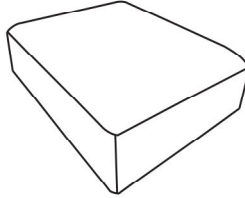
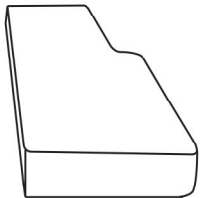
LISTE DES PIÈCES
PARTS LIST

PIÈCE / PART #	IMAGE	DESCRIPTION	QTY / QTÉ
1		SOFA SEAT FRAME STRUCTURE D'ASSISE DU CANAPÉ	1
2		SEAT FRAME CADRE D'ASSISE	1
3		BACK CUSHION COUSSIN DE DOSSIER	1
4		SEAT CUSHION COUSSIN D'ASSISE	2
5		CHAISE SEAT CUSHION COUSSIN D'ASSISE DE CHAISE LONGUE	1

LISTE DES PIÈCES
PARTS LIST

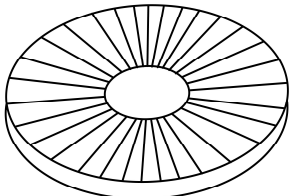
PIÈCE / PART #	IMAGE	DESCRIPTION	QTY / QTÉ
6		<p align="center">LEG PATTE</p>	8
7		<p align="center">SUPPORT LEG PATTE DE SUPPORT</p>	1
8		<p align="center">LEG SUPPORT SUPPORT DE PATTE</p>	1

LISTE DES PIÈCES DE MONTAGE
HARDWARE LIST

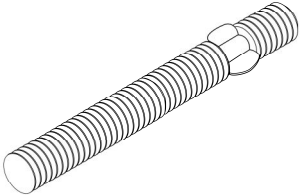
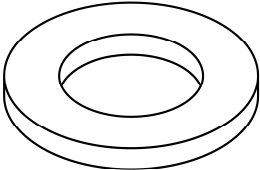
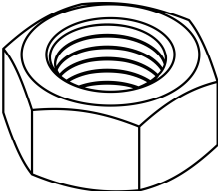
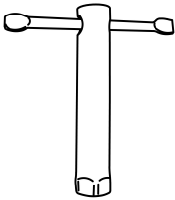
PIÈCE / PART #	IMAGE	DESCRIPTION	QTY / QTÉ
A		<p align="center">THREADED ROD TIGE FILETÉE</p>	1
B		<p align="center">METAL WASHER RONDELLE DE MÉTAL</p>	1
C		<p align="center">HEX NUT ÉCROU HEXAGONALE</p>	1
D		<p align="center">SPANNER CLÉ ANGLAISE</p>	1

LISTE DES PIÈCES DE MONTAGE
HARDWARE LIST

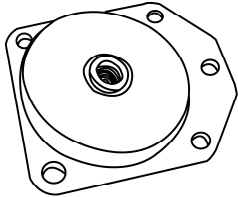
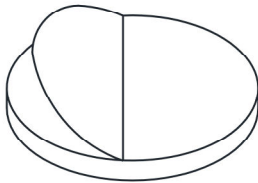
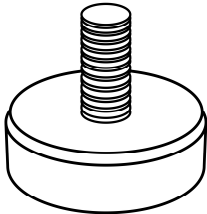
PIÈCE / PART #	IMAGE	DESCRIPTION	QTY / QTÉ
LISTE DES PIÈCES DE MONTAGE (DÉJÀ INSTALLÉES) HARDWARE LIST (ALREADY INSTALLED)			
E		BACK METAL BRACKETS (SET) ÉQUERRES MÉTAL - DOSSIER (ENS.)	2
F		SUPPORT SUPPORT	8
G		FLOOR PROTECTOR PROTECTEUR DE PLANCHER	8
H		ADJUSTABLE LEVELING LEG PATTE DE NIVELLEMENT AJUSTABLE	1

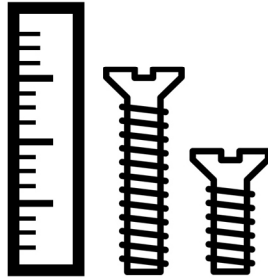

OUTIL DE VÉRIFICATION DE DIMENSIONS DES PIÈCES
HARDWARE DIMENSIONS VERIFICATION TOOL

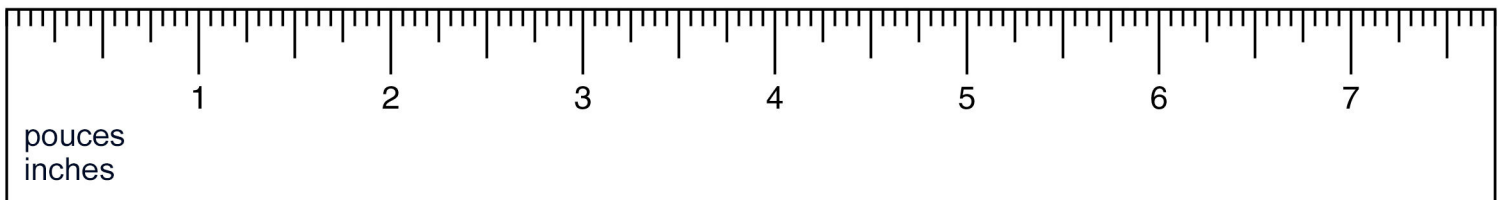

ÉTAPE / STEP 1

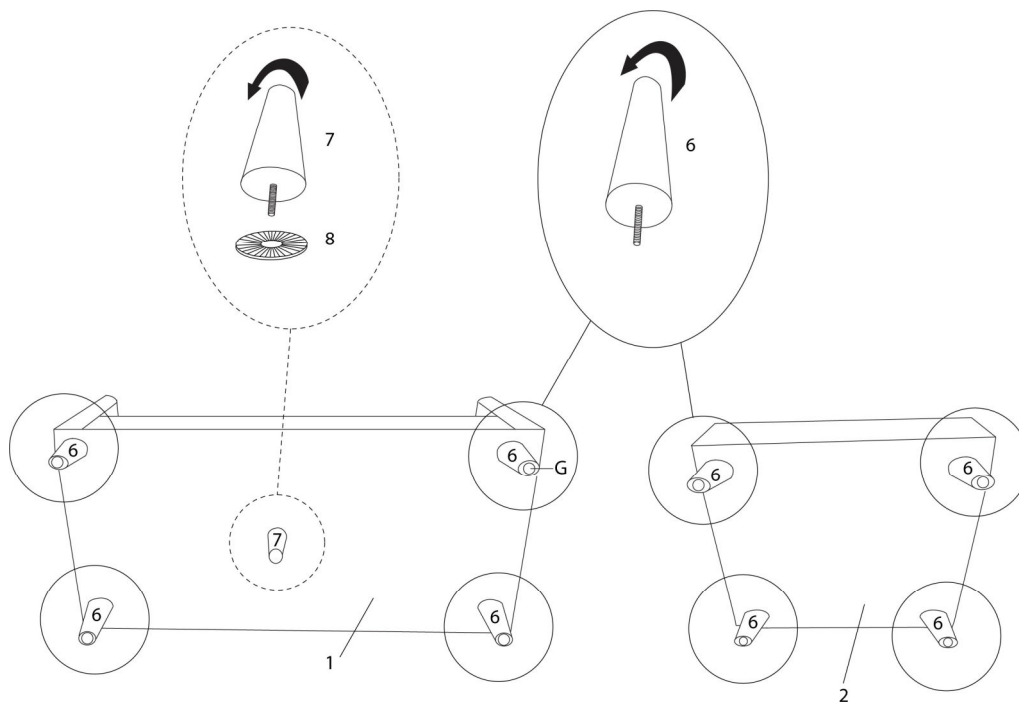

ÉTAPE / STEP 2

LONGUE - DROIT /
LOUNGER - RIGHT

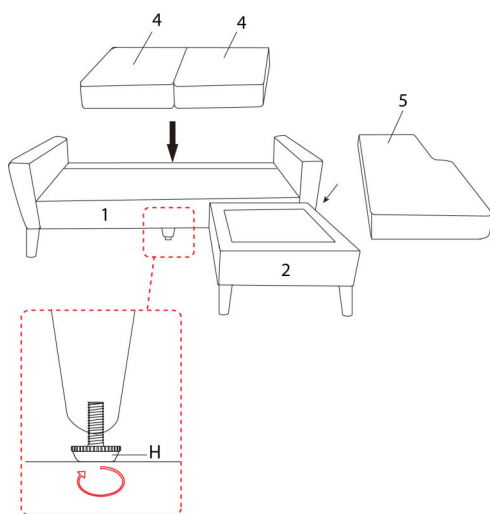

LONGUE - GAUCHE /
LOUNGER - LEFT

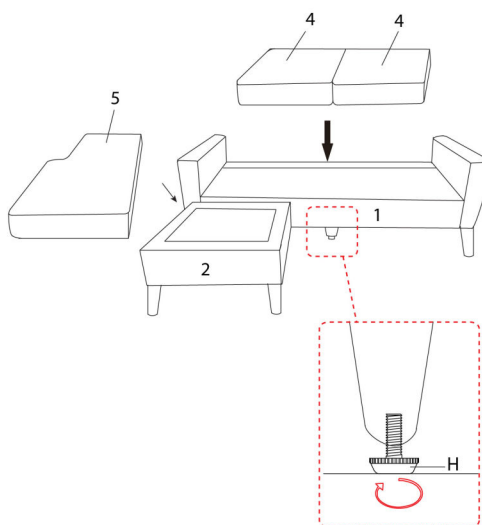

ÉTAPE / STEP 3

LONGUE - DROIT /
LOUNGER - RIGHT

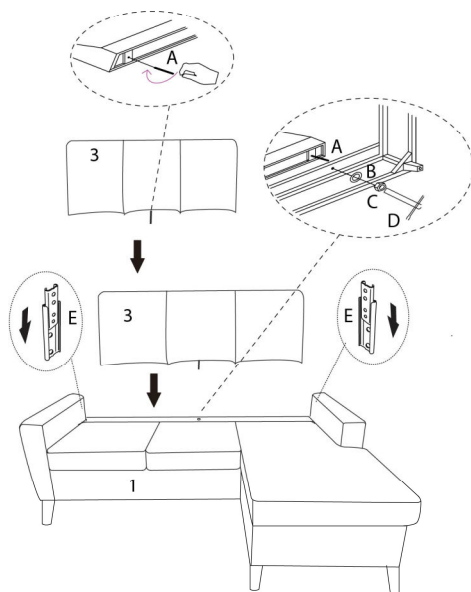

LONGUE - GAUCHE /
LOUNGER - LEFT

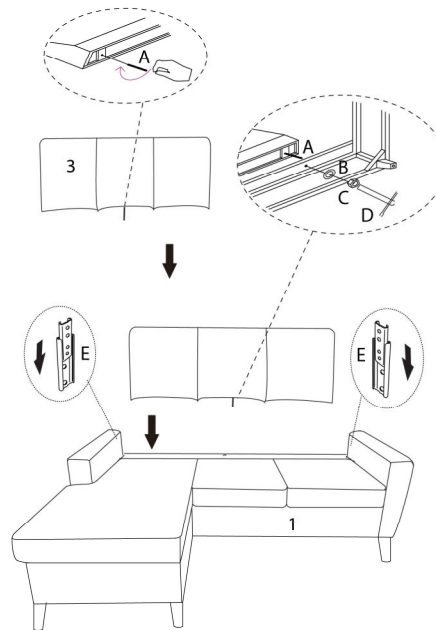

ÉTAPE / STEP 4

LONGUE - DROIT /
LOUNGER - RIGHT

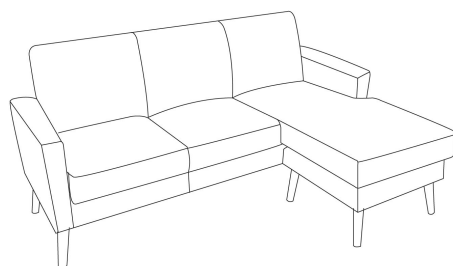

LONGUE - GAUCHE /
LOUNGER - LEFT

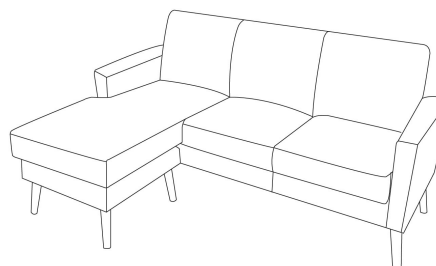

ÉTAPE / STEP 5

