



INSTRUCTIONS D'ASSEMBLAGE
ASSEMBLY INSTRUCTIONS

MONARCH
SPECIALTIES INC.

I 7211

BUREAU -
48" L / BLANC LUSTRE / METAL CHROME

COMPUTER DESK -
48" L / GLOSSY WHITE / CHROME METAL



**POUR DE L'ASSISTANCE OU POUR COMMANDER
DES PIÈCES CONTACTEZ NOTRE DÉPARTEMENT
DE SERVICE À LA CLIENTÈLE.**

**FOR ASSISTANCE OR TO ORDER PARTS
CONTACT OUR CUSTOMER SERVICE DEPARTMENT**

WWW.MONARCHSERVICE.COM

LISTE DES PIÈCES
PARTS LIST

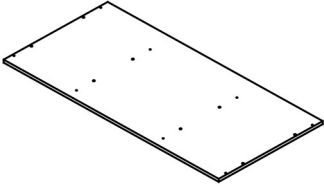
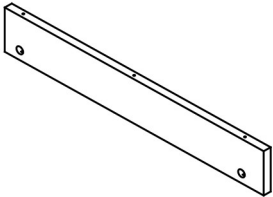
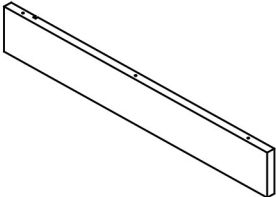
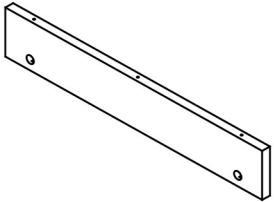
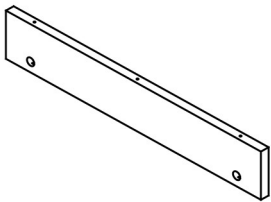
PIÈCE / PART #	IMAGE	DESCRIPTION	QTY / QTÉ
1		DESK TOP SURFACE DU BUREAU	1
2		FRONT FACING LEFT SIDE PANEL PANNEAU DE CÔTÉ GAUCHE	1
3		FRONT FACING RIGHT SIDE PANEL PANNEAU DE CÔTÉ AVANT DROIT	1
4		SUPPORT PANEL PANNEAU DE SOUTIENT	1
5		SUPPORT PANEL PANNEAU DE SOUTIENT	1

LISTE DES PIÈCES
PARTS LIST

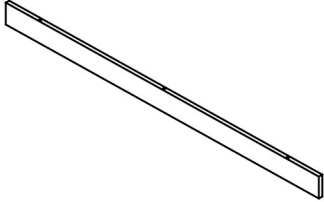
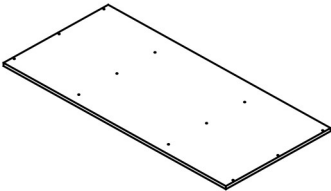
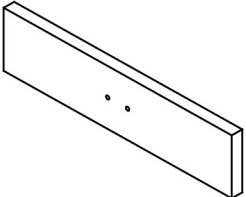
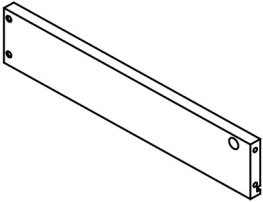
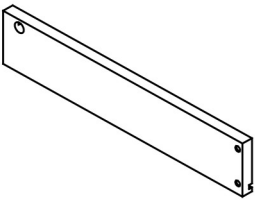
PIÈCE / PART #	IMAGE	DESCRIPTION	QTY / QTÉ
6		BACK PANEL PANNEAU ARRIÈRE	1
7		BOTTOM PANEL PANNEAU DU BAS	1
8		DRAWER FRONT PANEL PANNEAU AVANT TIROIR	2
9		DRAWER SIDE PANEL PANNEAU DE CÔTÉ TIROIR	2
10		DRAWER SIDE PANEL PANNEAU DE CÔTÉ TIROIR	2

LISTE DES PIÈCES
PARTS LIST

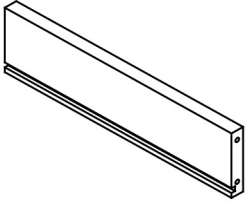
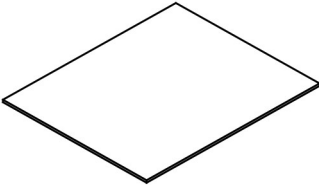
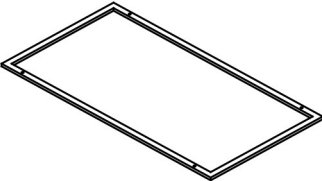
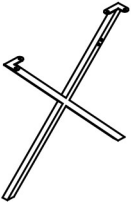
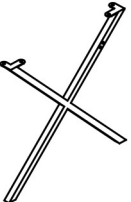
PIÈCE / PART #	IMAGE	DESCRIPTION	QTY / QTÉ
11		DRAWER BACK PANEL PANNEAU ARRIÈRE TIROIR	2
12		DRAWER BOTTOM PANEL PANNEAU DU BAS TIROIR	2
13		TOP FRAME CADRE DE SURFACE	1
14		FRONT FACING LEFT LEG PATTE AVANT GAUCHE	1
15		FRONT FACING RIGHT LEG PATTE AVANT DROITE	1

LISTE DES PIÈCES
PARTS LIST

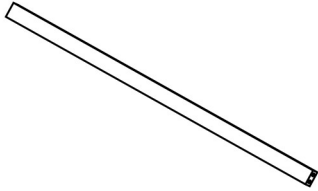
PIÈCE / PART #	IMAGE	DESCRIPTION	QTY / QTÉ
16		SUPPORT BAR BARRE DE SOUTIEN	1

LISTE DES PIÈCES DE MONTAGE
HARDWARE LIST

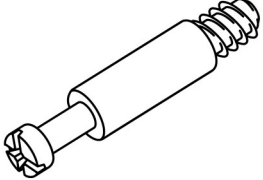
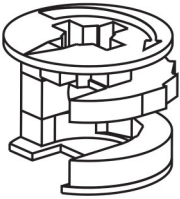
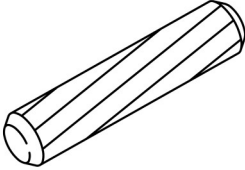
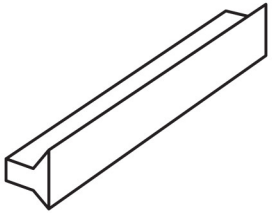
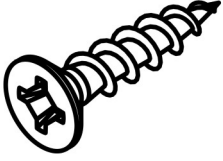
PIÈCE / PART #	IMAGE	DESCRIPTION	QTY / QTÉ
A		CAM LOCK SCREW - Ø1/8" X 1 1/2" VIS CAM LOCK - Ø1/8" X 1 1/2"	12
B		CAM LOCK CONNECTOR - Ø1/2" X 1/2" ÉCROU CAM LOCK - Ø1/2" X 1/2"	12
C		WOOD DOWEL - Ø3/8" X 1 1/8" GOUJON DE BOIS - Ø3/8" X 1 1/8"	22
D		HANDLE POIGNÉE	2
E		ASSEMBLING SCREW - Ø3/8" X 1 1/4" VIS D'ASSEMBLAGE - Ø3/8" X 1 1/4"	20

LISTE DES PIÈCES DE MONTAGE
HARDWARE LIST

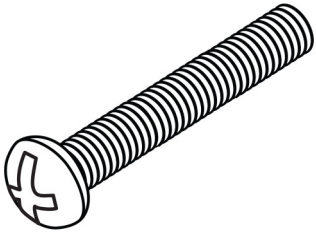
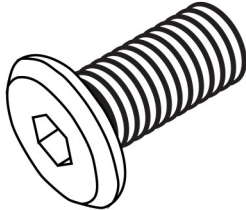
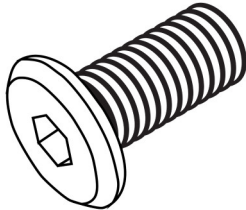
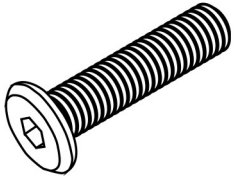
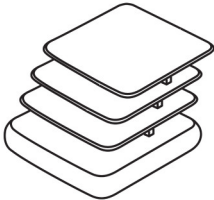
PIÈCE / PART #	IMAGE	DESCRIPTION	QTY / QTÉ
F		ASSEMBLING BOLT - Ø1/8" X 7/8" BOULON D'ASSEMBLAGE - Ø1/8" X 7/8"	4
G		ASSEMBLING BOLT - Ø1/4" X 1/2" BOULON D'ASSEMBLAGE - Ø1/4" X 1/2"	8
H		ASSEMBLING BOLT - Ø1/4" X 3/4" BOULON D'ASSEMBLAGE - Ø1/4" X 3/4"	4
I		ASSEMBLING BOLT - Ø1/4" X 2" BOULON D'ASSEMBLAGE - Ø1/4" X 2"	4
J		FLOOR PROTECTOR - 1" X 1" PROTECTEUR DE PLANCHER - 1" X 1"	4

LISTE DES PIÈCES DE MONTAGE
HARDWARE LIST

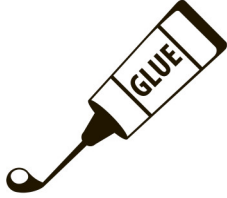
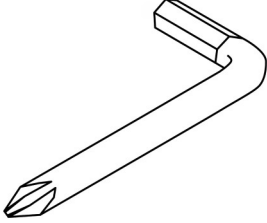
PIÈCE / PART #	IMAGE	DESCRIPTION	QTY / QTÉ
K		GLUE COLLE	1
L		HEX KEY CLÉ HEXAGONALE	1

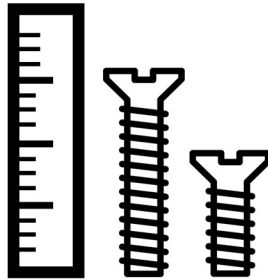

OUTIL DE VÉRIFICATION DE DIMENSIONS DES PIÈCES
HARDWARE DIMENSIONS VERIFICATION TOOL

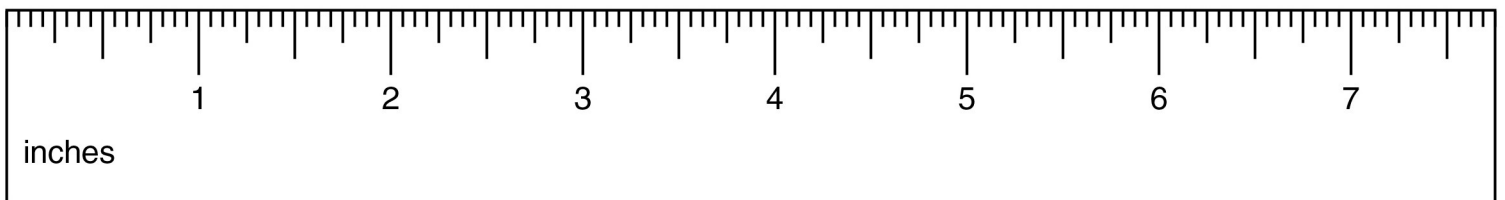

ÉTAPE / STEP 1

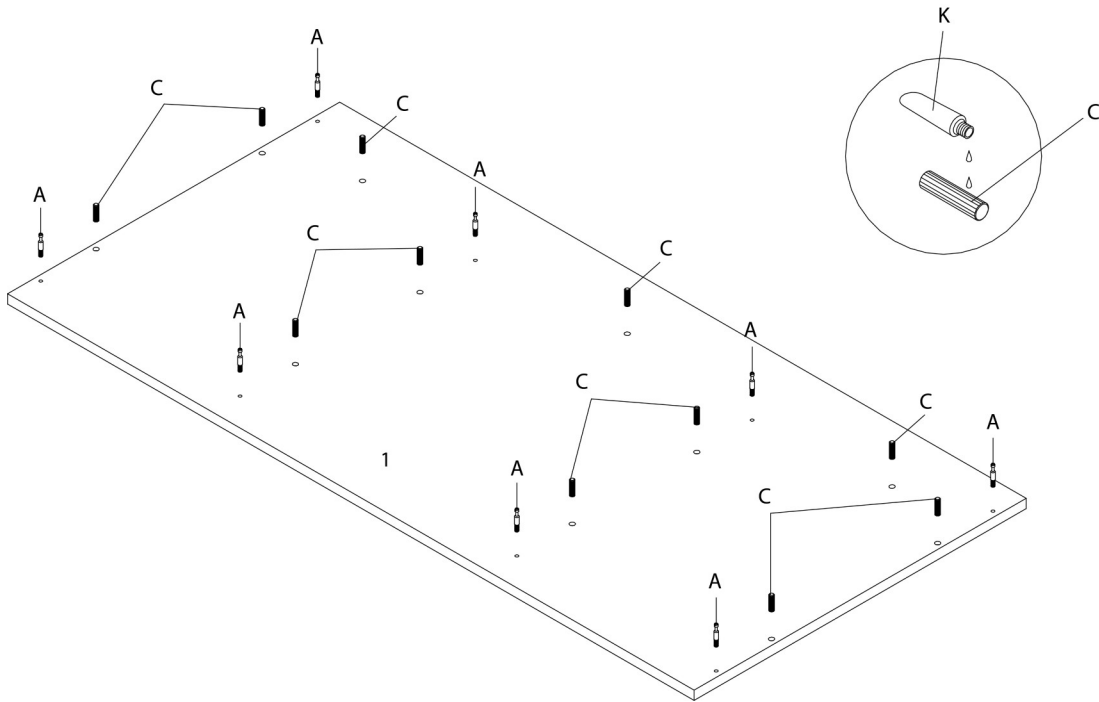

ÉTAPE / STEP 2

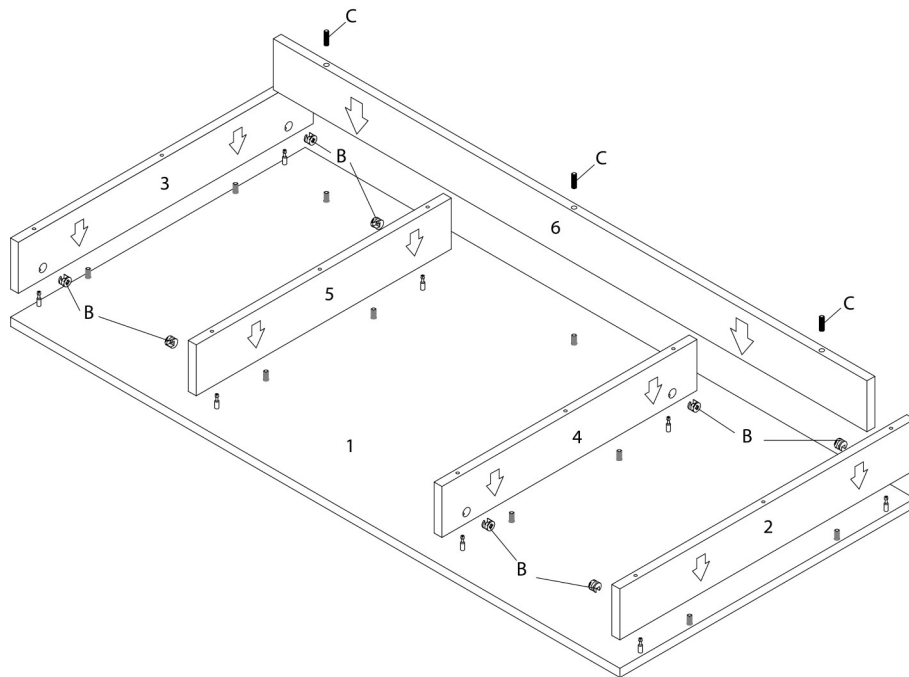

ÉTAPE / STEP 3

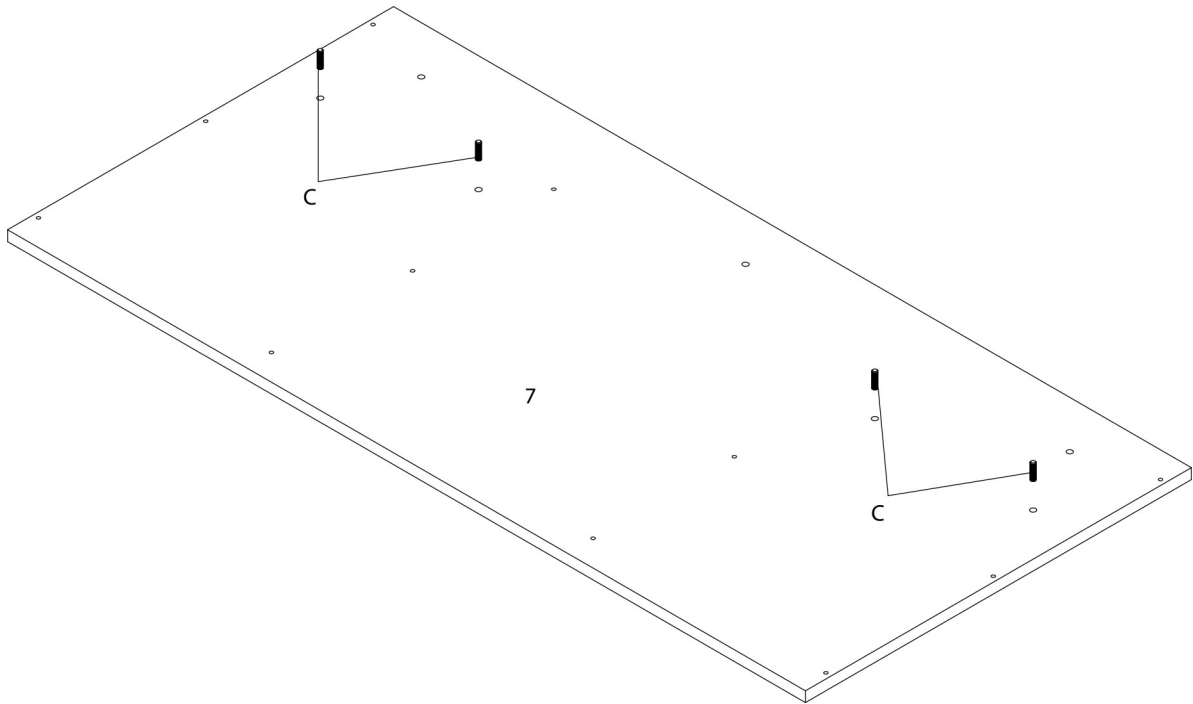

ÉTAPE / STEP 4

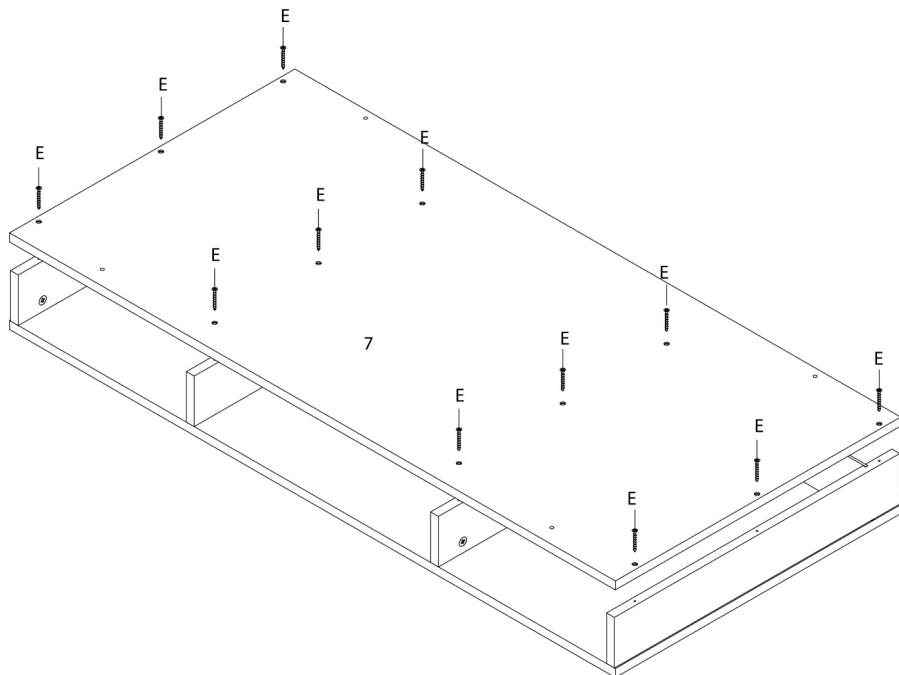

ÉTAPE / STEP 5

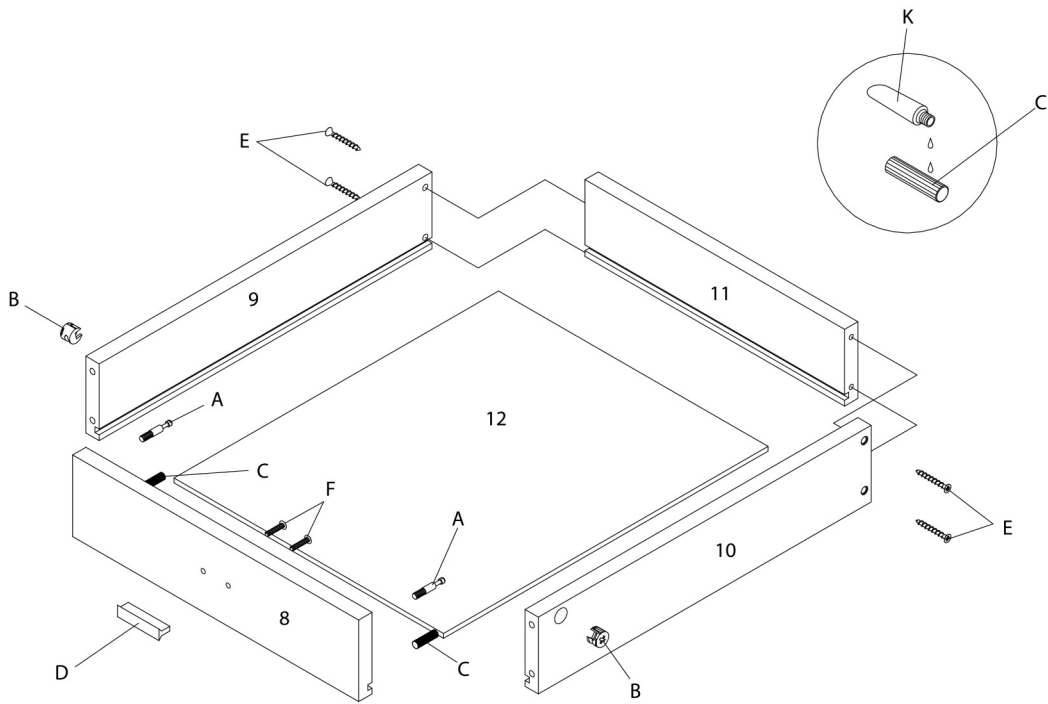

ÉTAPE / STEP 6

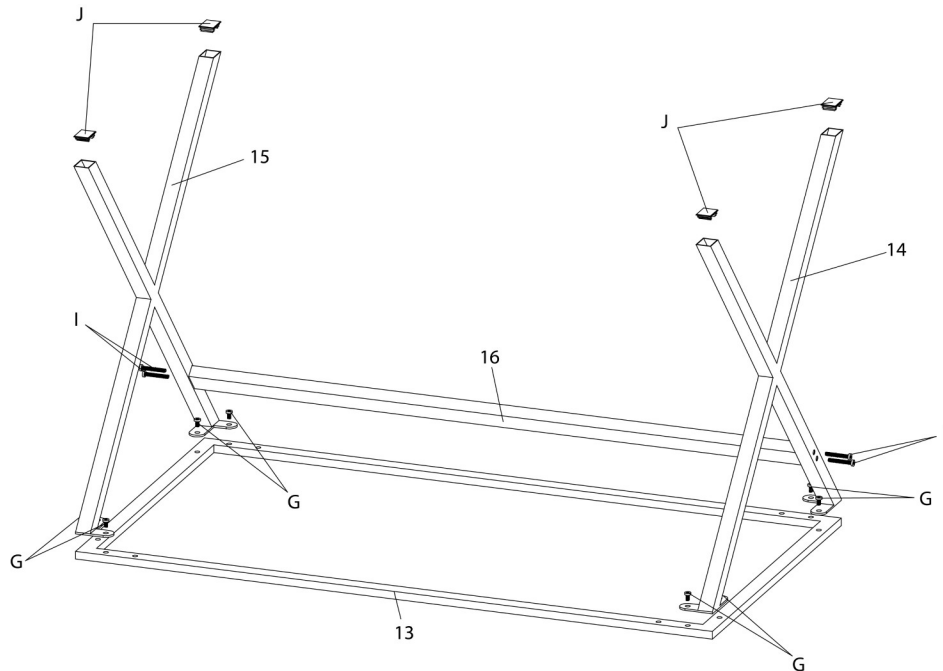

ÉTAPE / STEP 7

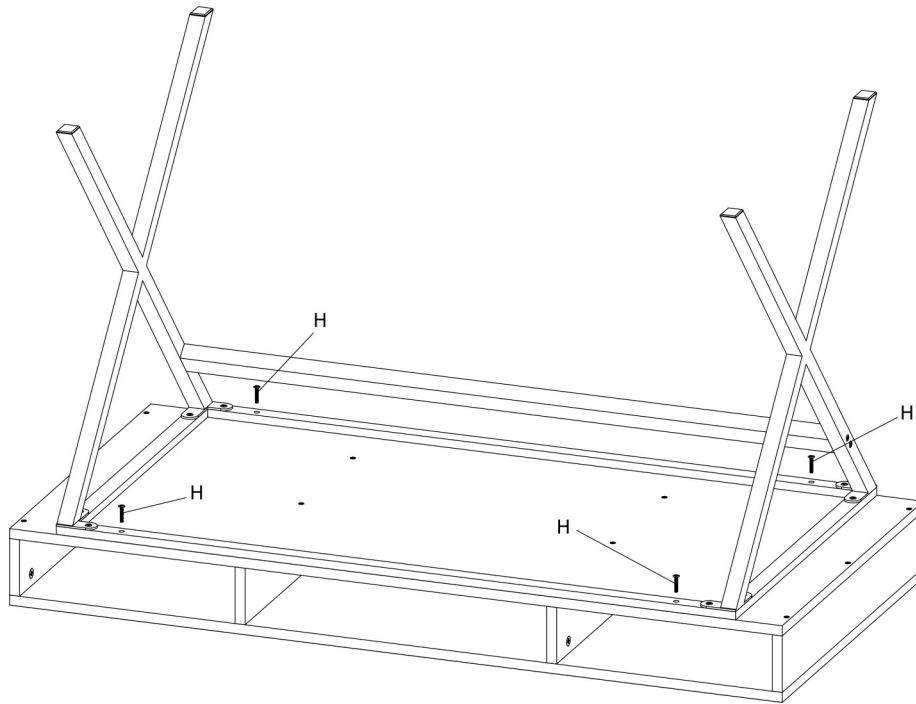

ÉTAPE / STEP 8

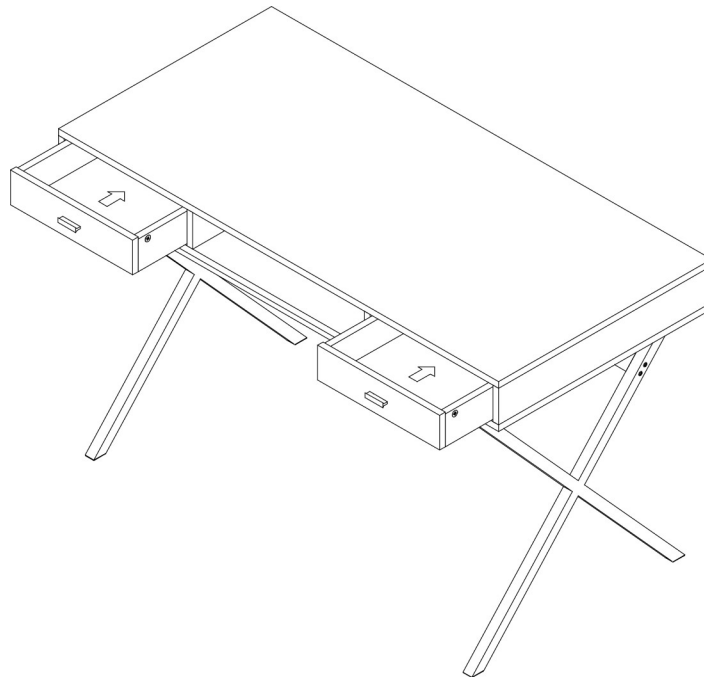

ÉTAPE / STEP 9

