



**INSTRUCTIONS D'ASSEMBLAGE**  
**ASSEMBLY INSTRUCTIONS**

---

**M**ONARCH  
SPECIALTIES INC.

# I 7201

---

**BUREAU -**  
**48"L / ESPRESSO / METAL OR**

**COMPUTER DESK -**  
**48"L / ESPRESSO / GOLD METAL**



**POUR DE L'ASSISTANCE OU POUR COMMANDER  
DES PIÈCES CONTACTEZ NOTRE DÉPARTEMENT  
DE SERVICE À LA CLIENTÈLE.**

**FOR ASSISTANCE OR TO ORDER PARTS  
CONTACT OUR CUSTOMER SERVICE DEPARTMENT**

**WWW.MONARCHSERVICE.COM**

**LISTE DES PIÈCES**  
**PARTS LIST**

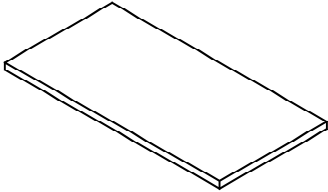
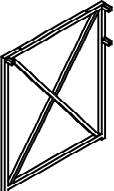
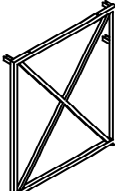
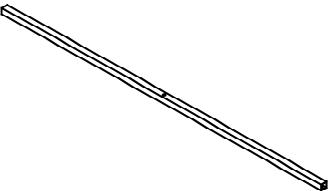
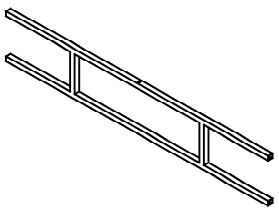
PIÈCE / PART #	IMAGE	DESCRIPTION	QTY / QTÉ
1		<p align="center"><b>DESK TOP</b>  <b>SURFACE DU BUREAU</b></p>	1
2		<p align="center"><b>FRONT FACING LEFT LEG</b>  <b>PATTE AVANT GAUCHE</b></p>	1
3		<p align="center"><b>FRONT FACING RIGHT LEG</b>  <b>PATTE AVANT DROITE</b></p>	1
4		<p align="center"><b>SUPPORT BAR</b>  <b>BARRE DE SOUTIEN</b></p>	1
5		<p align="center"><b>BACK FRAME</b>  <b>CADRE DU DOSSIER</b></p>	1

**LISTE DES PIÈCES DE MONTAGE**  
**HARDWARE LIST**

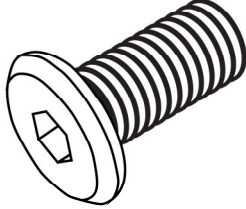
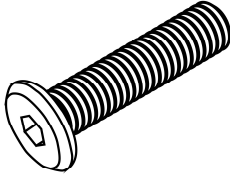
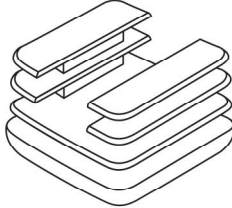
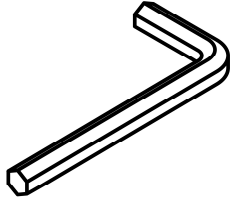
PIÈCE / PART #	IMAGE	DESCRIPTION	QTY / QTÉ
A		<p align="center">ASSEMBLING BOLT - Ø1/4" X 1/2"</p> <p align="center">BOULON D'ASSEMBLAGE - Ø1/4" X 1/2"</p>	12
B		<p align="center">ASSEMBLING BOLT - Ø1/4" X 1 1/4"</p> <p align="center">BOULON D'ASSEMBLAGE - Ø1/4" X 1 1/4"</p>	6
C		<p align="center">FLOOR PROTECTOR - 3/4" X 3/4"</p> <p align="center">PROTECTEUR DE PLANCHER - 3/4" X 3/4"</p>	4
D		<p align="center">HEX KEY</p> <p align="center">CLÉ HEXAGONALE</p>	1



OUTIL DE VÉRIFICATION DE DIMENSIONS DES PIÈCES  
HARDWARE DIMENSIONS VERIFICATION TOOL



ÉTAPE / STEP 1

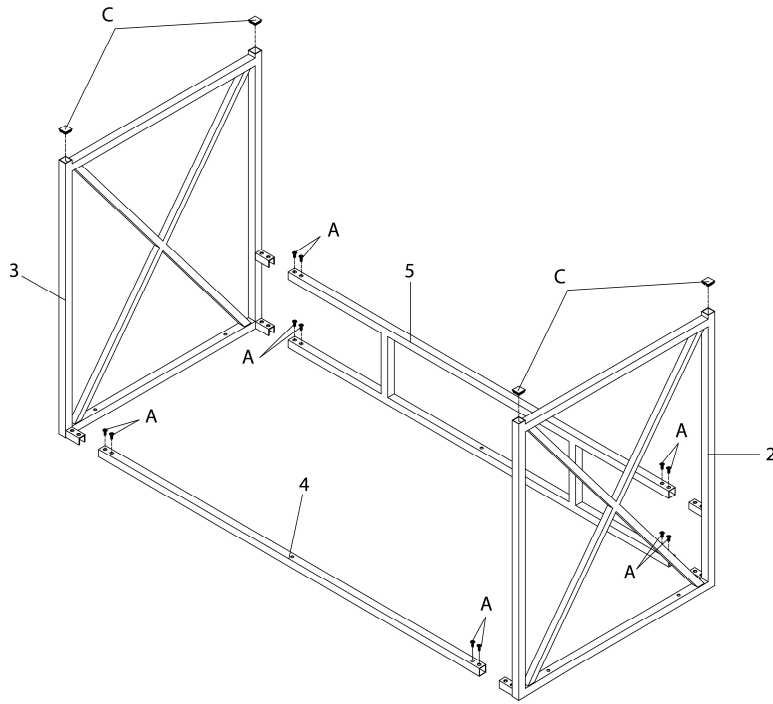

ÉTAPE / STEP 2

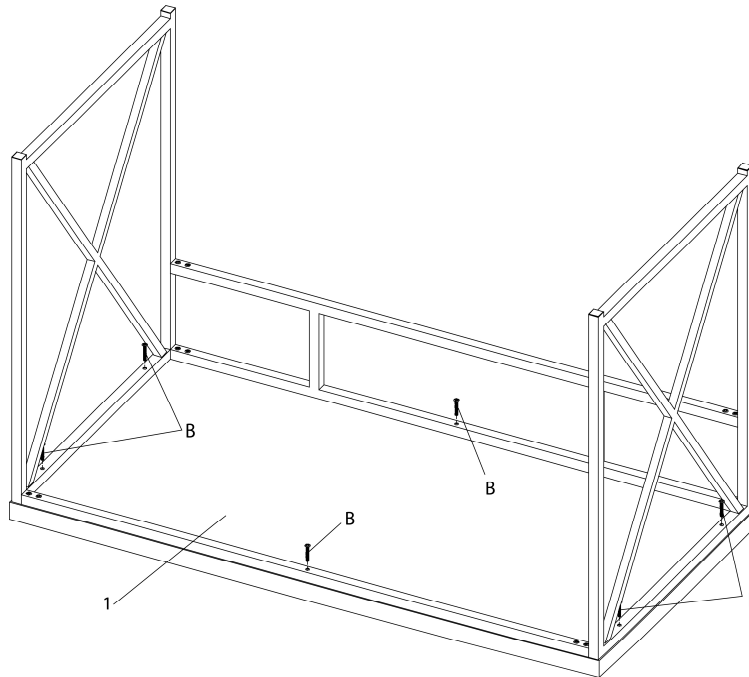

ÉTAPE / STEP 3

