



INSTRUCTIONS D'ASSEMBLAGE
ASSEMBLY INSTRUCTIONS

MONARCH
SPECIALTIES INC.

I 4511

BANC -
72" H / HALL D'ENTREE TAUPE FONCE / METAL NOIR

BENCH -
72" H / DARK TAUPE / BLACK METAL HALL ENTRY



**POUR DE L'ASSISTANCE OU POUR COMMANDER
DES PIÈCES CONTACTEZ NOTRE DÉPARTEMENT
DE SERVICE À LA CLIENTÈLE.**



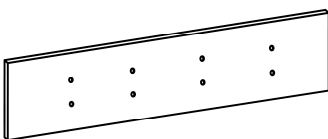
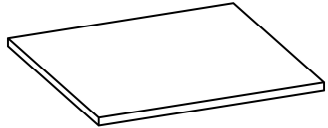
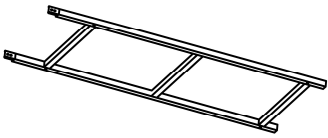
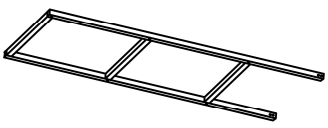

**FOR ASSISTANCE OR TO ORDER PARTS
CONTACT OUR CUSTOMER SERVICE DEPARTMENT**

WWW.MONARCHSERVICE.COM

LISTE DES PIÈCES
PARTS LIST

PIÈCE / PART #	IMAGE	DESCRIPTION	QTY / QTÉ
1		SHELF PANEL PANNEAU DE TABLETTE	1
2		TOP PANEL PANNEAU DE SURFACE	1
3		SHELF PANEL PANNEAU DE TABLETTE	5
4		BOTTOM POST POTEAU DU BAS	2
5		UPPER POST POTEAU SUPÉRIEUR	1

LISTE DES PIÈCES
PARTS LIST

PIÈCE / PART #	IMAGE	DESCRIPTION	QTY / QTÉ
6		METAL LEG PATTE EN METAL	1
7		METAL TUBE TUBE EN MÉTAL	1
8		SUPPORT BAR BARRE DE SOUTIEN	4
9		SUPPORT BAR BARRE DE SOUTIEN	1
10		SHELF SUPPORT BAR BARRE DE SOUTIEN POUR TABLETTE	10

LISTE DES PIÈCES
PARTS LIST

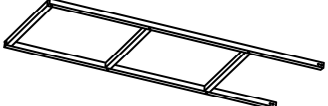
PIÈCE / PART #	IMAGE	DESCRIPTION	QTY / QTÉ
11		TOP STRETCHER CHÂSSIS SUPÉRIEUR	1
12		UPPER POST POTEAU SUPÉRIEUR	1

LISTE DES PIÈCES DE MONTAGE
HARDWARE LIST

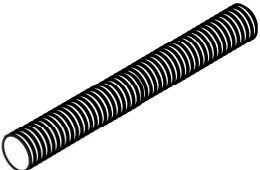
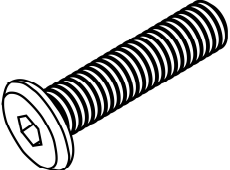
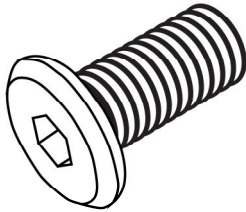
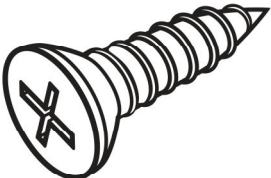
PIÈCE / PART #	IMAGE	DESCRIPTION	QTY / QTÉ
A		HOOK CROCHET	4
B		THREADED ROD - 1/4" X 2 3/8" TIGE FILETÉE - 1/4" X 2 3/8"	4
C		ASSEMBLING BOLT - 1/4" X 1 5/8" BOULON D'ASSEMBLAGE - 1/4" X 1 5/8"	24
D		ASSEMBLING BOLT - 1/4" X 3/8" BOULON D'ASSEMBLAGE - 1/4" X 3/8"	18
E		ASSEMBLING SCREW - 1/8" X 1/2" VIS D'ASSEMBLAGE - 1/8" X 1/2"	32

LISTE DES PIÈCES DE MONTAGE
HARDWARE LIST

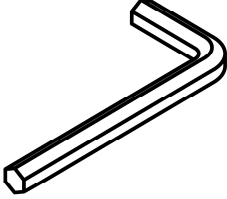
PIÈCE / PART #	IMAGE	DESCRIPTION	QTY / QTÉ
F		HEX KEY CLÉ HEXAGONALE	1

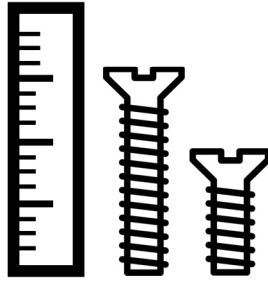

OUTIL DE VÉRIFICATION DE DIMENSIONS DES PIÈCES
HARDWARE DIMENSIONS VERIFICATION TOOL

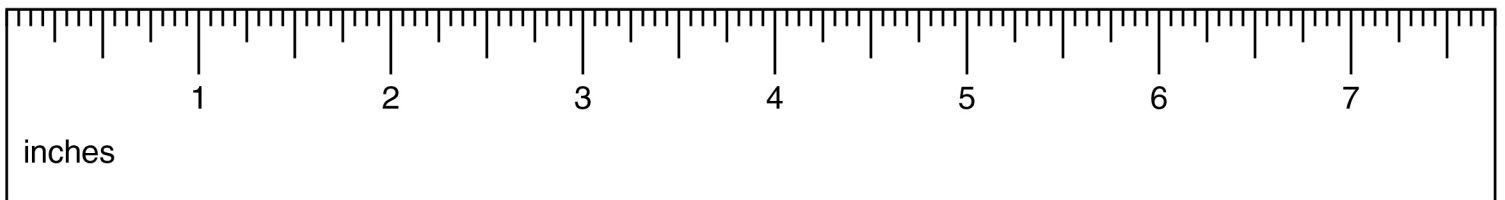

ÉTAPE / STEP 1

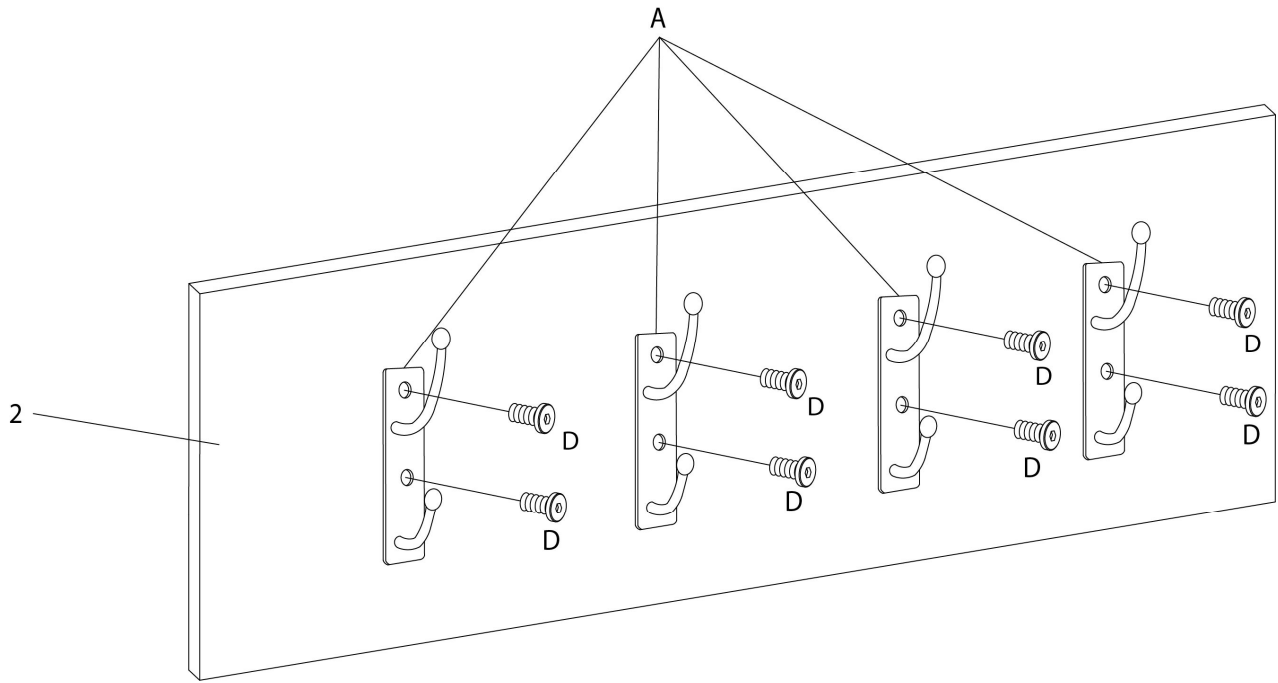

ÉTAPE / STEP 2

GAUCHE / LEFT

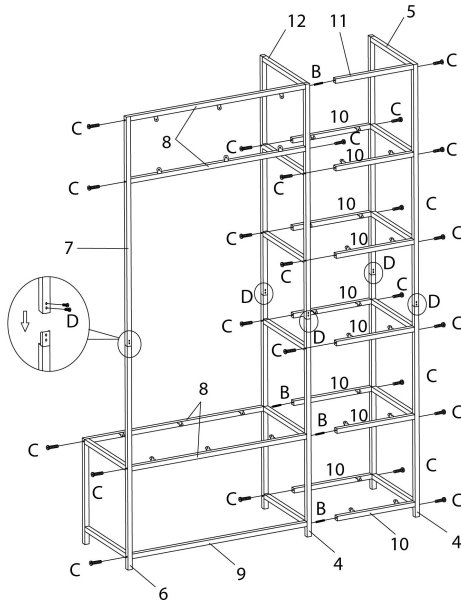

DROIT / RIGHT

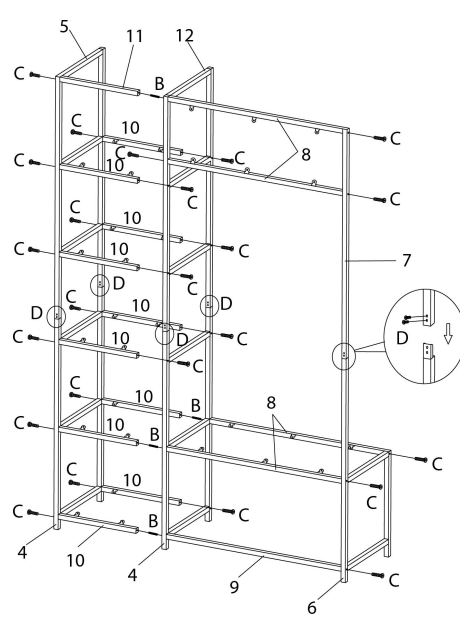

ÉTAPE / STEP 3

GAUCHE / LEFT

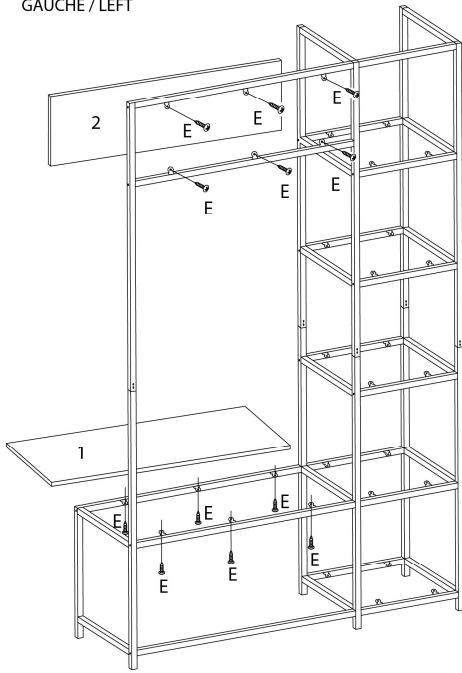

DROIT / RIGHT

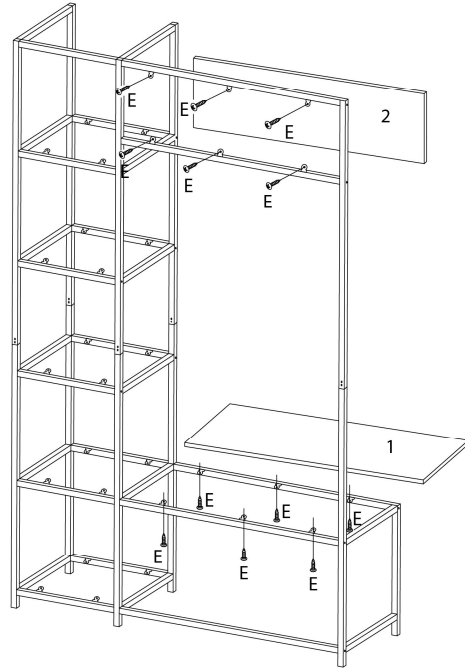

ÉTAPE / STEP 4

GAUCHE / LEFT

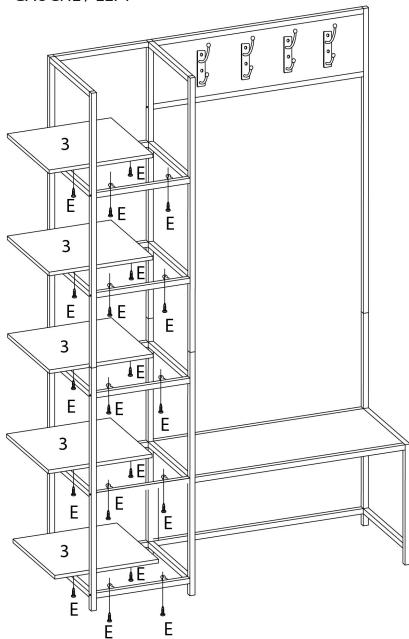

DROIT / RIGHT

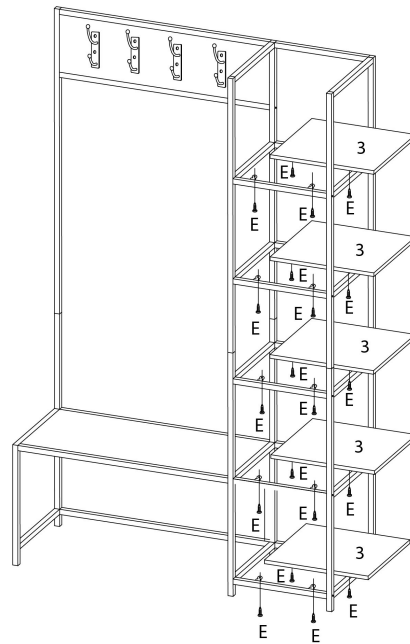

ÉTAPE / STEP 5

