





OJAS-502-513

Assembly Instruction/ Instructions D' assemblage

Hardware List / Liste de Materiel

 H1 x 8	 H2 x 8	 H3 x 4	 H4 x 1
---	--	--	--

Parts List / Liste des Pieces

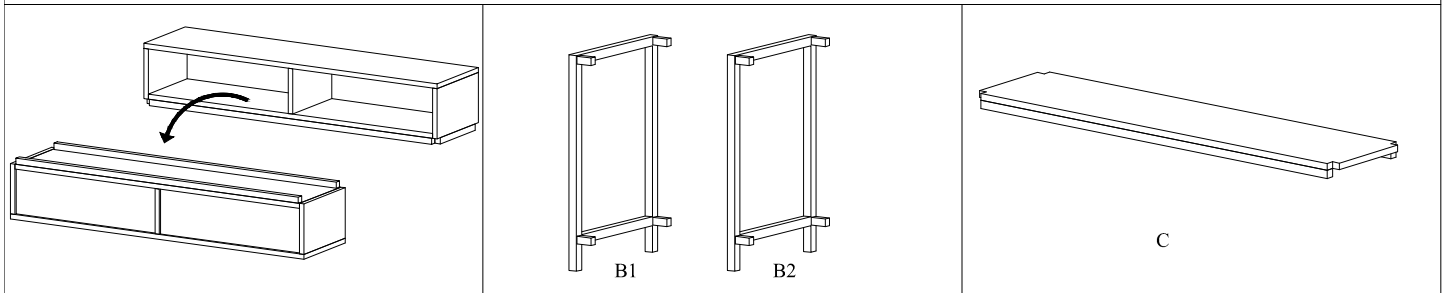

Step.1 / Etape .1

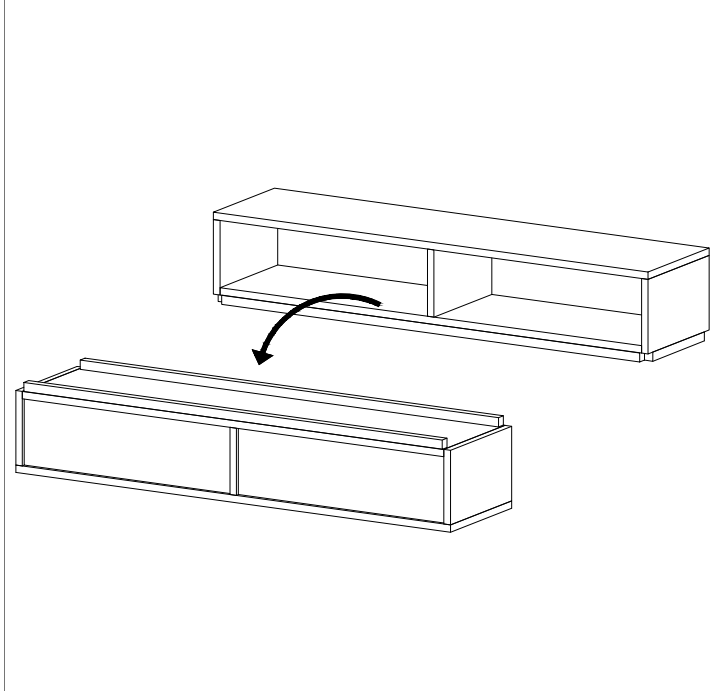

Step.2 / Etape .2

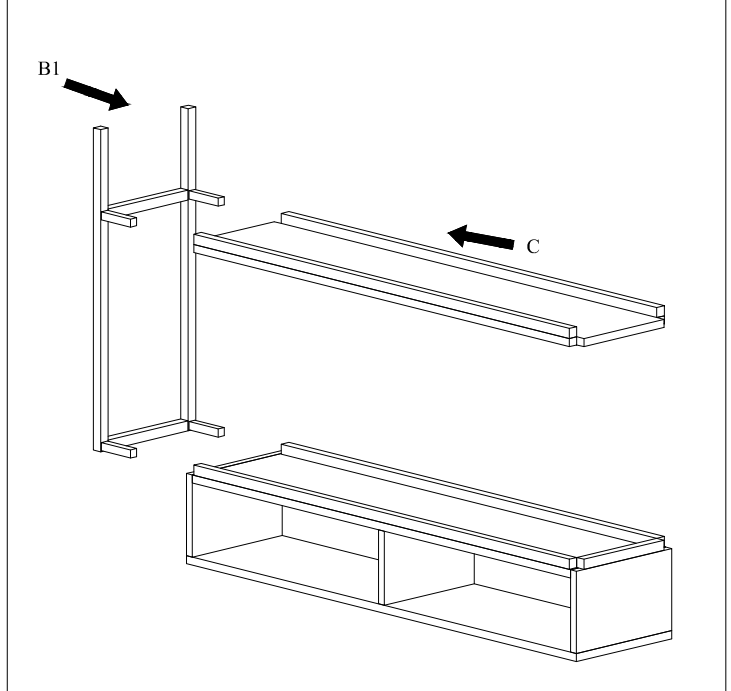

Step.3 / Etape .3

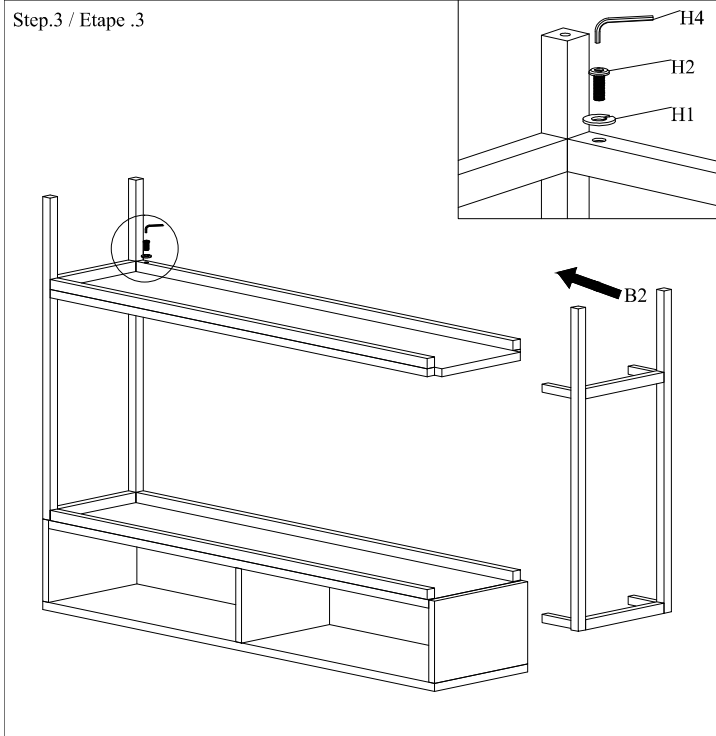

Step.4 / Etape .4

