



INSTRUCTIONS D'ASSEMBLAGE
ASSEMBLY INSTRUCTIONS

MONARCH
SPECIALTIES INC.

I 5920T

LIT -
SIMPLE / TISSUS GRIS

BED -
TWIN SIZE / GREY LINEN



**POUR DE L'ASSISTANCE OU POUR COMMANDER
DES PIÈCES CONTACTEZ NOTRE DÉPARTEMENT
DE SERVICE À LA CLIENTÈLE.**



**FOR ASSISTANCE OR TO ORDER PARTS
CONTACT OUR CUSTOMER SERVICE DEPARTMENT**

WWW.MONARCHSERVICE.COM

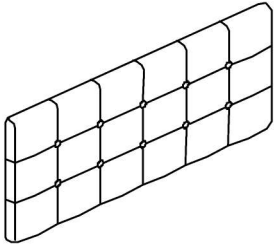
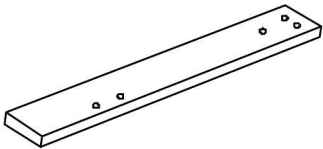
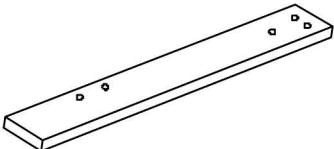
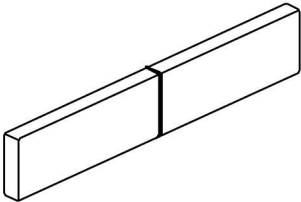
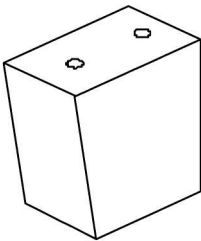

LISTE DES PIÈCES
PARTS LIST

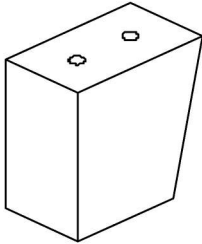
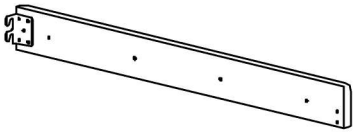
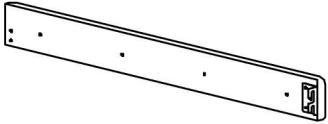
PIÈCE / PART #	IMAGE	DESCRIPTION	QTY / QTÉ
1		HEADBOARD TÊTE DE LIT	1
2		FRONT FACING HEADBOARD LEFT LEG TÊTE DE LIT AVANT GAUCHE	1
3		FRONT FACING HEADBOARD RIGHT LEG TÊTE DE LIT AVANT DROITE	1
4		FOOTBOARD PIED DE LIT	1
5		FRONT FACING FOOTBOARD LEFT LEG PIED DE LIT AVANT GAUCHE	1

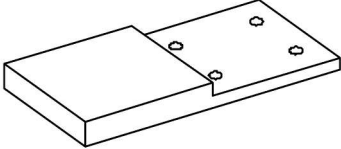

LISTE DES PIÈCES
PARTS LIST

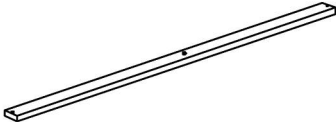
PIÈCE / PART #	IMAGE	DESCRIPTION	QTY / QTÉ
6		<p>FRONT FACING FOOTBOARD RIGHT LEG PIED DE LIT AVANT DROIT</p>	1
7		<p>FRONT FACING LEFT SIDE RAIL RAIL DE CÔTÉ GAUCHE</p>	2
8		<p>FRONT FACING RIGHT SIDE RAIL RAIL DE CÔTÉ DROIT</p>	2
9		<p>SUPPORT BAR BARRE DE SOUTIEN</p>	4
10		<p>SIDE RAIL SUPPORT LEG RAIL DE CÔTÉ PATTE DE SOUTIEN</p>	2

LISTE DES PIÈCES
PARTS LIST

PIÈCE / PART #	IMAGE	DESCRIPTION	QTY / QTÉ
11		SLAT LAMELLE	4
12		SUPPORT LEG PATTE DE SOUTIEN	4

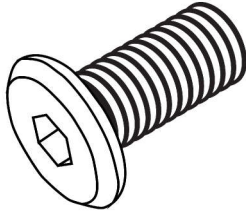
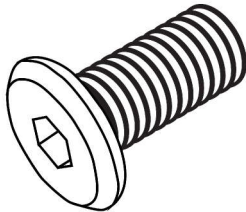
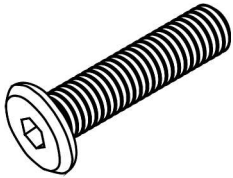
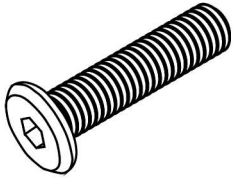
LISTE DES PIÈCES DE MONTAGE
HARDWARE LIST

PIÈCE / PART #	IMAGE	DESCRIPTION	QTY / QTÉ
A		ASSEMBLING BOLT - Ø 3/8" X 3/4" BOULON D'ASSEMBLAGE - Ø 3/8" X 3/4"	8
B		ASSEMBLING BOLT - Ø 1/4" X 1" BOULON D'ASSEMBLAGE - Ø 1/4" X 1"	8
C		ASSEMBLING BOLT - Ø 1/4" X 1 3/8" BOULON D'ASSEMBLAGE - Ø 1/4" X 1 3/8"	20
D		ASSEMBLING BOLT - Ø 1/4" X 2" BOULON D'ASSEMBLAGE - Ø 1/4" X 2"	6
E		ASSEMBLING BOLT - Ø 1/4" X 2 3/4" BOULON D'ASSEMBLAGE - Ø 1/4" X 2 3/4"	2

LISTE DES PIÈCES DE MONTAGE
HARDWARE LIST

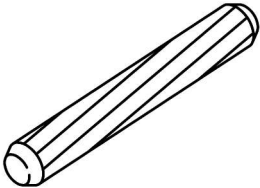
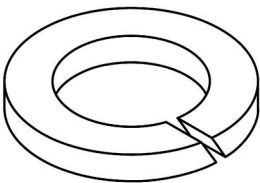
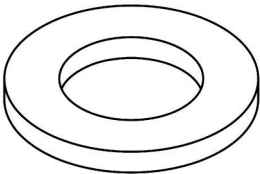
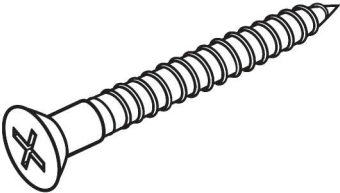
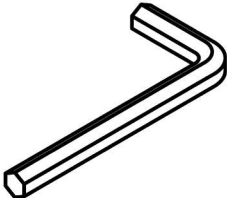
PIÈCE / PART #	IMAGE	DESCRIPTION	QTY / QTÉ
F		WOOD DOWEL GOUJON DE BOIS	2
G		LOCK WASHER ENTRETOISE DE MÉTAL	30
H		METAL WASHER RONDELLE DE MÉTAL	30
I		ASSEMBLING SCREW - Ø 1/8" X 1 1/4" VIS D'ASSEMBLAGE - Ø 1/8" X 1 1/4"	8
J		HEX KEY - M5, 4M CLÉ HEXAGONALE - M5, 4M	1

LISTE DES PIÈCES DE MONTAGE
HARDWARE LIST

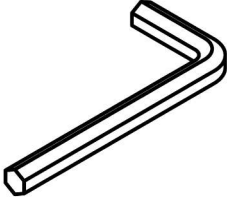
PIÈCE / PART #	IMAGE	DESCRIPTION	QTY / QTÉ
K		HEX KEY - M4 , 3M CLÉ HEXAGONALE - M4 , 3M	1

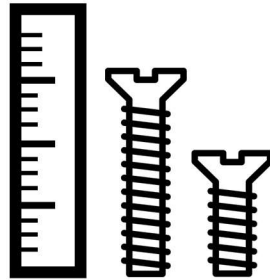

OUTIL DE VÉRIFICATION DE DIMENSIONS DES PIÈCES
HARDWARE DIMENSIONS VERIFICATION TOOL

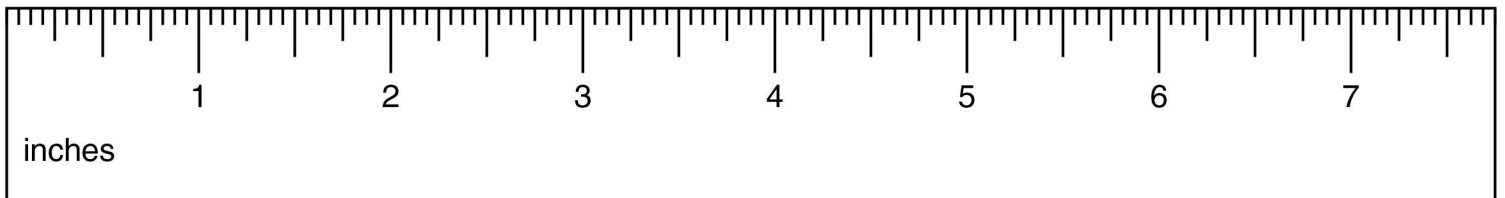

ÉTAPE / STEP 1

La quincaillerie et les composants sont situés dans l'unité de la tête de lit.

Hardware and components are located in the headboard unit.

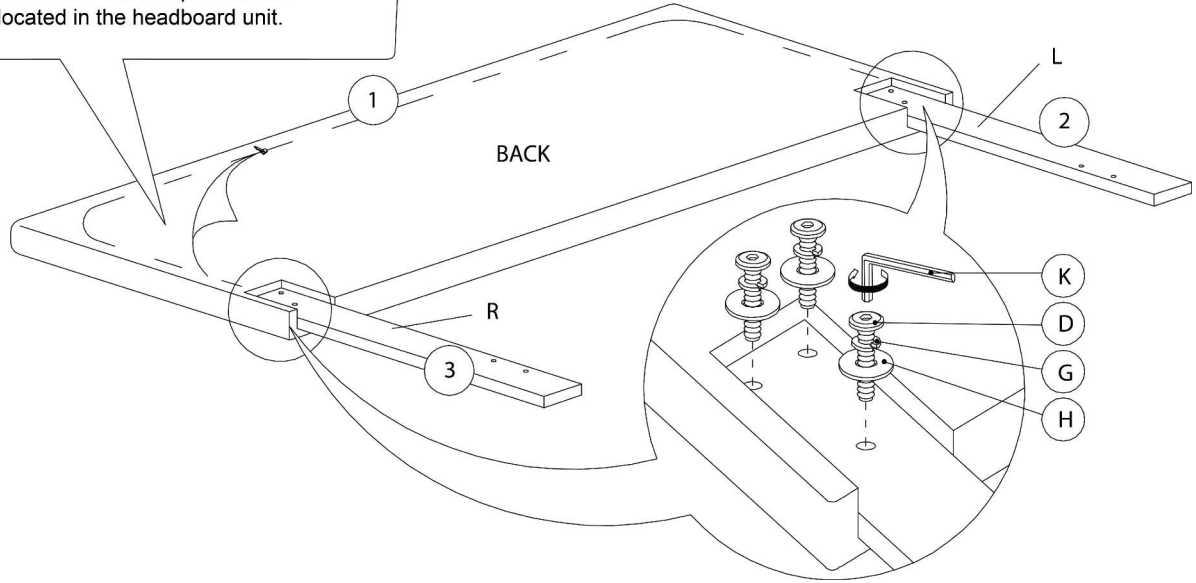

ÉTAPE / STEP 2

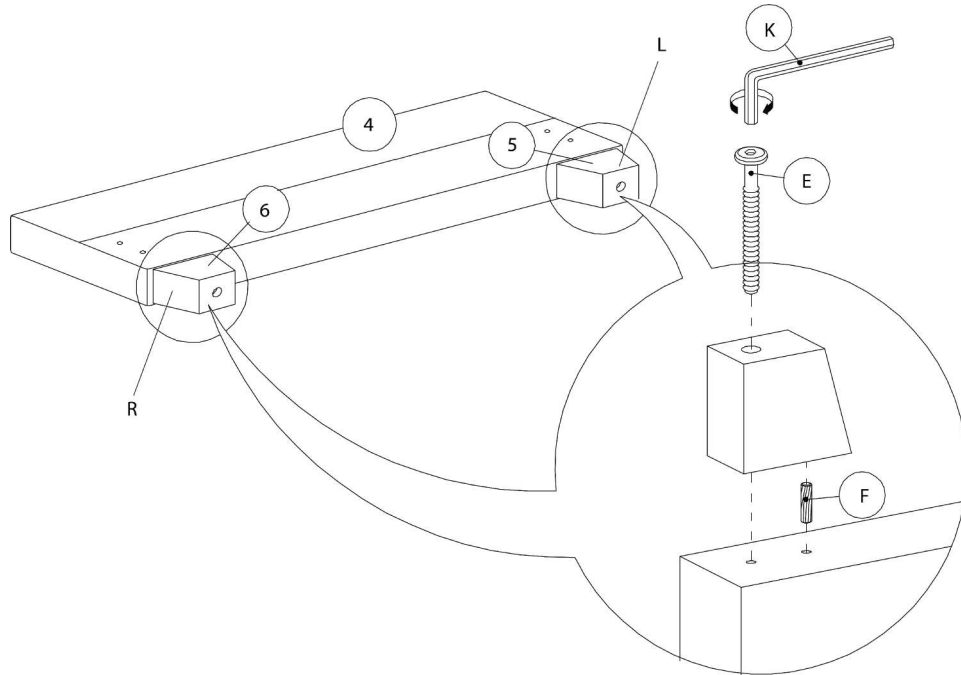

ÉTAPE / STEP 3

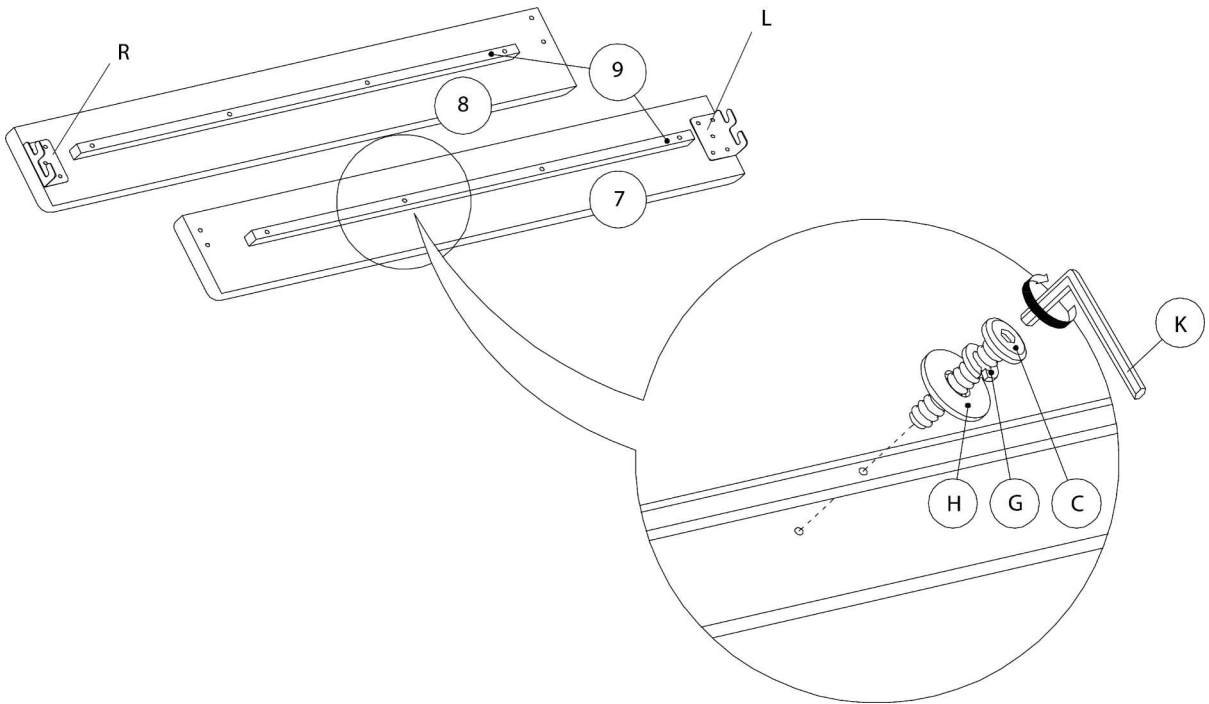

ÉTAPE / STEP 4

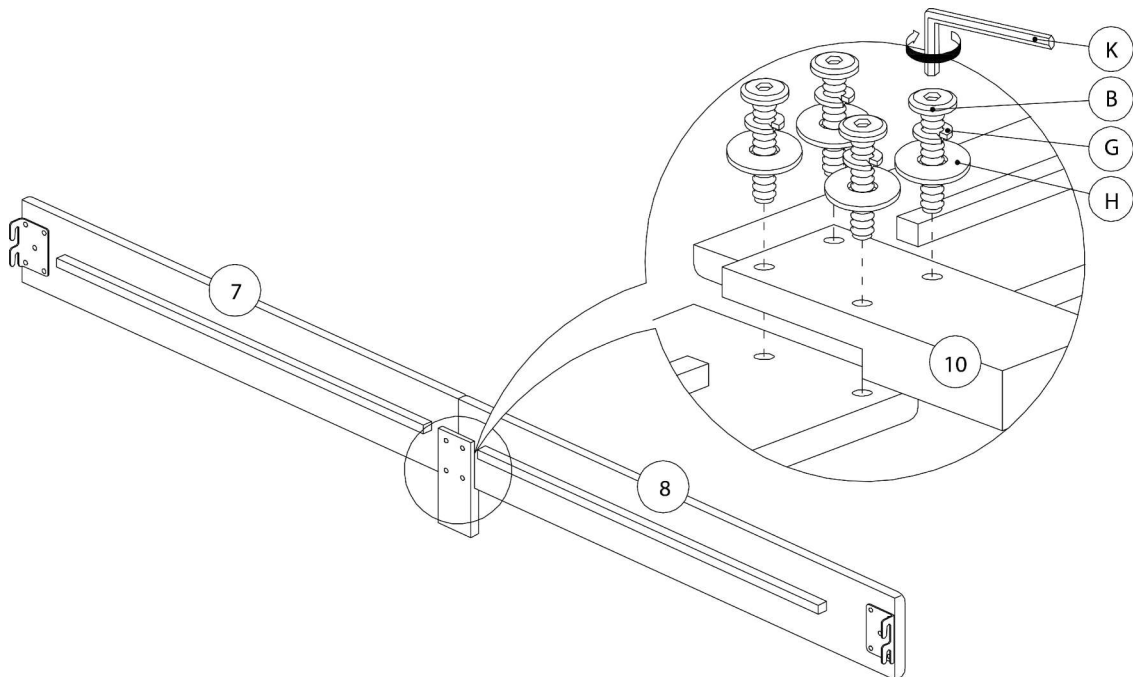

ÉTAPE / STEP 5

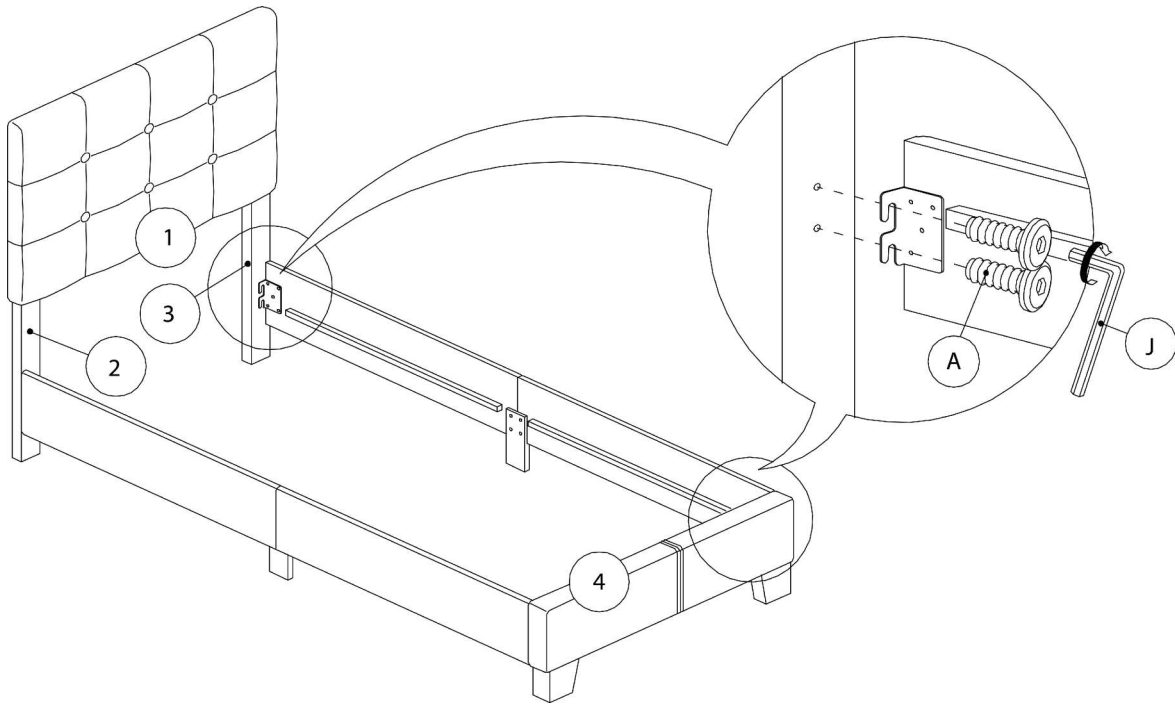

ÉTAPE / STEP 6

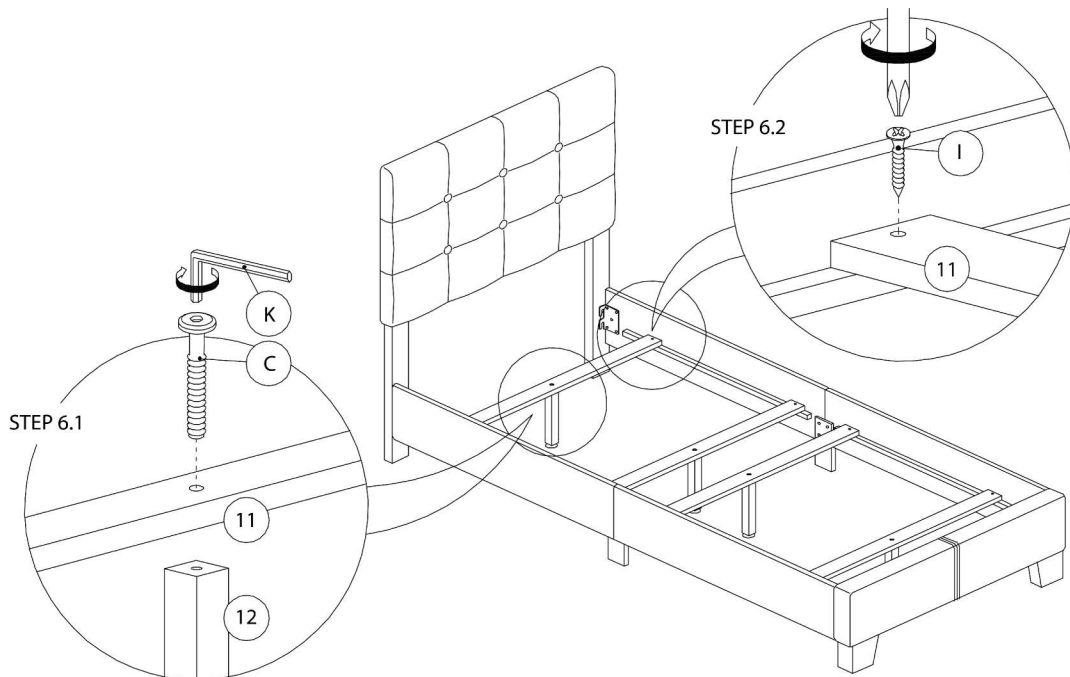

ÉTAPE / STEP 7

