



**INSTRUCTIONS D'ASSEMBLAGE**  
**ASSEMBLY INSTRUCTIONS**

---

**M**ONARCH  
SPECIALTIES INC.

# I 2325

---

**BAR MAISON -**  
**24"X 36" / MARBRE GRIS / METAL CHARBON**

**HOME BAR -**  
**24"X 36" / GREY MARBLE / CHARCOAL METAL**



**POUR DE L'ASSISTANCE OU POUR COMMANDER  
DES PIÈCES CONTACTEZ NOTRE DÉPARTEMENT  
DE SERVICE À LA CLIENTÈLE.**



**FOR ASSISTANCE OR TO ORDER PARTS  
CONTACT OUR CUSTOMER SERVICE DEPARTMENT**

**WWW.MONARCHSERVICE.COM**

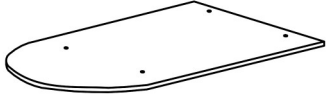
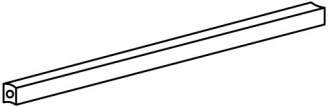
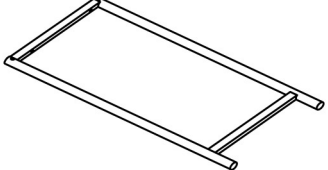
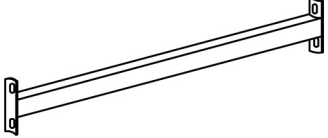
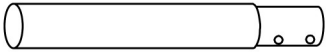
**LISTE DES PIÈCES**  
**PARTS LIST**

PIÈCE / PART #	IMAGE	DESCRIPTION	QTY / QTÉ
1		BAR TOP SURFACE DU BAR	1
2		SUPPORT BAR BARRE DE SOUTIEN	2
3		SIDE FRAME CADRE DE CÔTÉ	2
4		CROSSBAR BARRE TRANSVERSALE	2
5		TABLE LEG FOR EXTENSION PATTE DE TABLE POUR EXTENSION	4

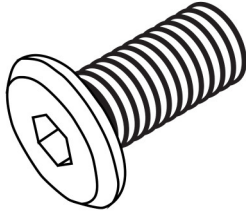
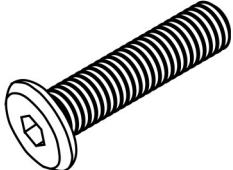
**LISTE DES PIÈCES DE MONTAGE**  
**HARDWARE LIST**

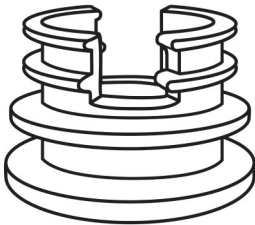
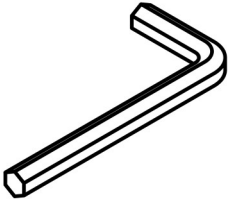
PIÈCE / PART #	IMAGE	DESCRIPTION	QTY / QTÉ
A		<p align="center">ASSEMBLING BOLT - Ø 1/4" X 3/4"</p> <p align="center">BOULON D'ASSEMBLAGE - Ø 1/4" X 3/4"</p>	16
B		<p align="center">ASSEMBLING BOLT - Ø 1/4" X 1 3/4"</p> <p align="center">BOULON D'ASSEMBLAGE - Ø 1/4" X 1 3/4"</p>	4
C		<p align="center">ASSEMBLING BOLT - Ø 1/4" X 1 1/8"</p> <p align="center">BOULON D'ASSEMBLAGE - Ø 1/4" X 1 1/8"</p>	4
D		<p align="center">FLOOR PROTECTOR - Ø 1"</p> <p align="center">PROTECTEUR DE PLANCHER - Ø 1"</p>	4
E		<p align="center">HEX KEY</p> <p align="center">CLÉ HEXAGONALE</p>	1

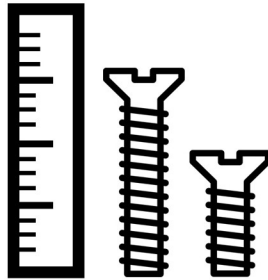

OUTIL DE VÉRIFICATION DE DIMENSIONS DES PIÈCES  
HARDWARE DIMENSIONS VERIFICATION TOOL

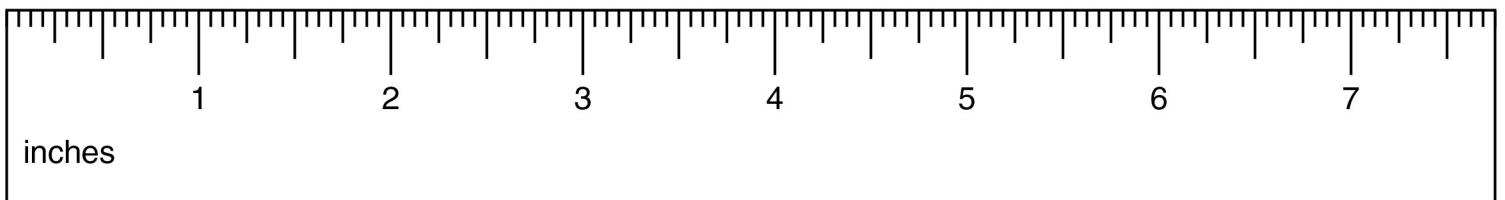

ÉTAPE / STEP 1

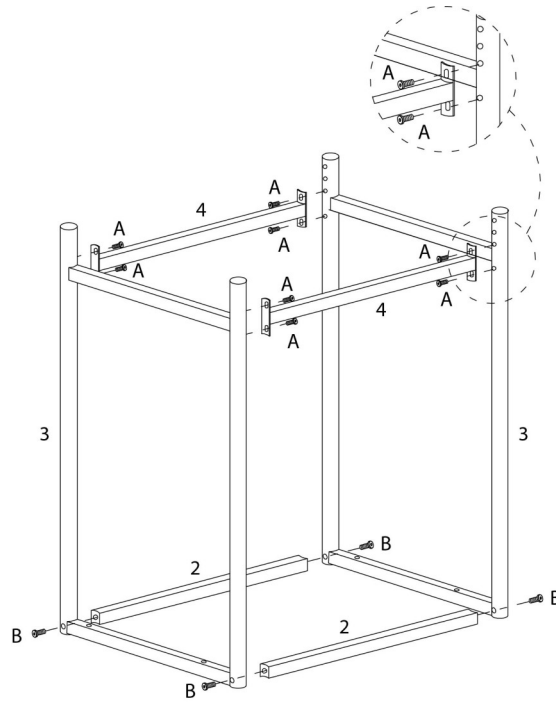

ÉTAPE / STEP 2

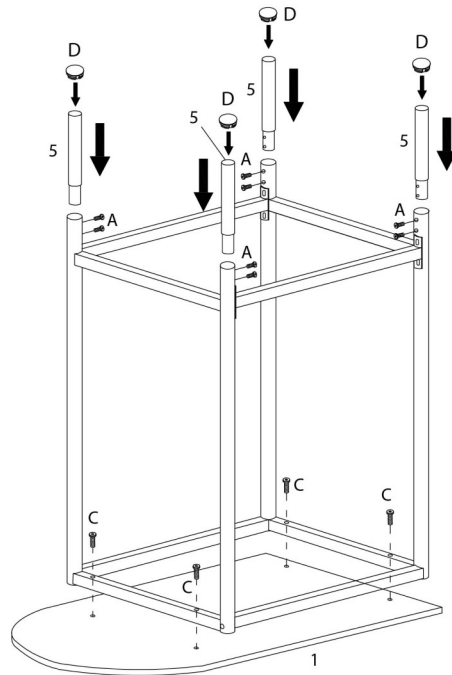

ÉTAPE / STEP 3

